



JUMBO LINE SERIES. INTELLI-TUB®

EXTRA-LUXURY HYDROTHERAPY TUBS FOR COMMERCIAL AND RESIDENTIAL USE. LARGE SIZE.

SEE DETAILED SPECS FOR EACH TUB (MODEL) AT PPG 32-37.

ALL RMS® PRODUCTS ARE PROUDLY MADE IN THE USA.

EMAIL: mail@relaxmedsyst.com
WEBSITE: www.relaxmedsyst.com

RMS® (RELAX MEDICAL SYSTEMS INC.),
3260 EAST WILLOW STREET,
SIGNAL HILL, CA, 90755, USA.

PHONE: 1-(800) 405-7677
1- (562) 331-9962
FAX: 1- (562)427-5285

C-280T MA-08
"CRYSTAL COVE LIMITED EDITION."



INTELLI-TUB®

C-280T MA-08 "CRYSTAL COVE."



INTELLI-TUB®

C-280T MA-08 "SEA BREEZE."



INTELLI-TUB®

C-280T MA-08 "SEACORAL."



C-280T MA-08 "SEABAY SPA."



C-280T MA-08
"OCEAN FLOWER."



RMS®

WORLD'S
#1
SPA
TUBS

CONTENTS

CHAPTER	DESCRIPTION	PAGE
1	JUMBO LINE INTELLI-TUB® PHOTO GALLERY.	4-37
2	LAYOUTS, WET ROOM SPA PACKAGES, TECHNICAL REQUIREMENTS FOR INSTALLATION, EXAMPLES OF INSTALLATION.	38-68
3	SPECIFICATIONS. JUMBO LINE SERIES.	69-76
3.1	<ul style="list-style-type: none"> ➤ C-280 T MA-08 <i>CRYSTAL COVE LIMITED EDITION</i> INTELLI-TUB®. ➤ C-280 T MA-08 <i>CRYSTAL COVE</i> INTELLI-TUB®. ➤ C-280 T MA-08 <i>SEA BREEZE</i> INTELLI-TUB®. 	69-72
3.2	<ul style="list-style-type: none"> ➤ C-280T MB-08 <i>SEA CORAL INTELLI-TUB®</i>. ➤ C-280T MC-08/S <i>SEABAY SPA</i>. ➤ C-280 T MC-08/O <i>OCEAN FLOWER</i>. 	73-76
4	OPTIONS FOR ALL JUMBO LINE TUB MODELS.	77-97
4.1	INTELLI TUB® ADDITIONAL LEVELS/FUNCTIONS. <u><i>APPLICABLE TO MODELS MARKED INTELLI TUB® ONLY.</i></u>	77-79
4.2	ACCESSORIES FOR JUMBO LINE PLATINUM HYDROTHERAPY TUB WET ROOM SPA PACKAGES. HYDROTOP® AND “OT” OVER-THE-TUB AFFUSION/VICHY SHOWERS.	80-82
4.3	“BASIC SET” OF UNDERWATER MASSAGE SYSTEM/EQUIPMENT WITH PERMANENTLY ATTACHED HOSE/NOZZLE (CAN NOT BE DISCONNECTED/DETACHED BETWEEN TREATMENTS) NOTE: UWM EQUIPMENT IS FULLY INSTALLED ON THE TUB DURING PRODUCTION.	83
4.4	UNDERWATER MASSAGE HOSE/HAND WAND SYSTEMS QRS AND QRS SW <u><i>WITH DETACHABLE</i></u> UNDERWATER MASSAGE HOSES.	84
4.5	SPECIFICATIONS. QRS AND QRS SW QUICK CONNECT UWM SYSTEMS.	85-87
4.6	UNDERWATER MASSAGE HOSE/HAND WAND SYSTEMS QRS SW WHICH INCLUDES ADDITIONAL SET OF HOSES WITH 3PCS. DIFFERENT TYPES OF UNDERWATER MASSAGE NOZZLES. UNIQUE DESIGN OF THE SYSTEM ALLOWS TO CHANGE THE HOSE WITH THE NOZZLE WITHIN 10 SECONDS WITHOUT INTERRUPTING THE TREATMENT.	88

4.7	ADDITIONAL SETS OF ASSEMBLY HOSES AND NOZZLES FOR QRS UNDERWATER MASSAGE SYSTEM. WITH RMS® QRS SYSTEM YOU CAN USE 3 DIFFERENT TYPES OF NOZZLES FOR DIFFERENT TYPES OF UNDERWATER MASSAGE TREATMENTS. GROW YOUR BUSINESS! YOUR CUSTOMERS WILL APPRECIATE IT; CUSTOMER RETENTION WILL BE IMPROVED. EXPAND YOUR SPA MENU, ADD TWO MORE NOZZLES AND MANY NEW TREATMENTS.	89
4.8	AFFUSION/VICHY SHOWERS FOR USE OVER RMS® TUBS. 1. “VO-7-OT EXCLUSIVE” SERIES WITH 180° SWIVEL BASE (14PCS. SHOWER HEADS) 2. “VO-7-OT STANDARD” (7PCS. SHOWER HEADS) NOTE 1: OPTIONAL RMS® HYDROTOP® SYSTEM FOR THE TUB IS REQUIRED. NOTE 2: CUSTOM RAIN BAR LENGTH AVAILABLE UPON REQUEST.	89
4.8.1	“VO-7-OT EXCLUSIVE” SERIES WITH 180° SWIVEL BASE. 14 PCS. SHOWER HEADS.	91-93
4.8.2	“VO-7 SW-OT STANDARD” SERIES WITH 180° SWIVEL BASE. 7 PCS. SHOWER HEADS.	94-97
5	EXAMPLES OF JUMBO LINE TUBS . SHIPPING DIMENSIONS AND WEIGHTS.	98-99
6	EXAMPLES OF JUMBO LINE TUBS . SHIPPING DIMENSIONS AND WEIGHTS.	100-101

CHAPTER 1. PHOTO GALLERY.
JUMBO LINE SPA INTELLI TUB®(S)

WHO IS IT FOR?



5-STAR HOTELS



Luxury Day Spas

Luxury Wellness Centers

Steam Rooms, Banyas, Hammam Centers

Luxury private residences





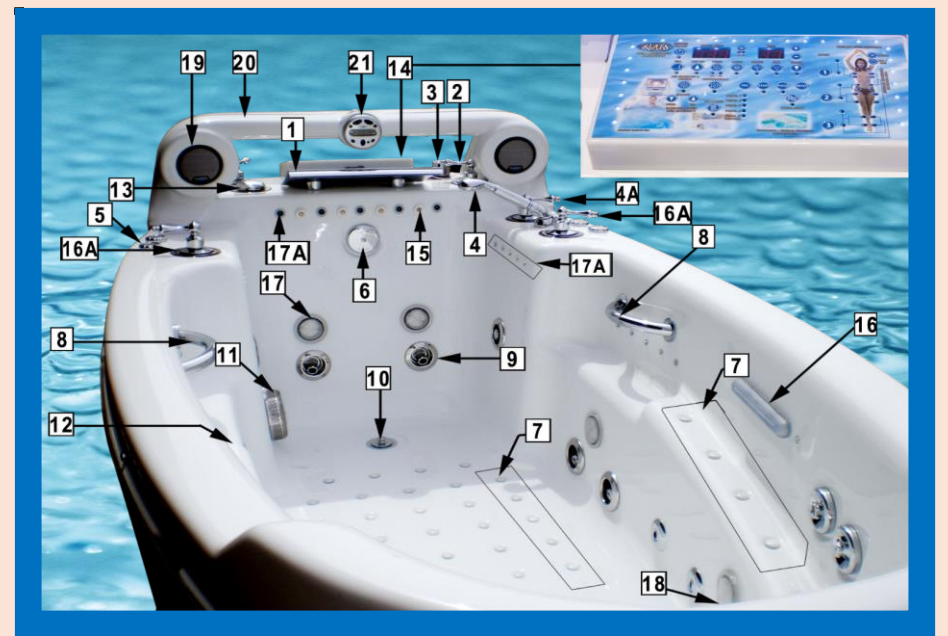
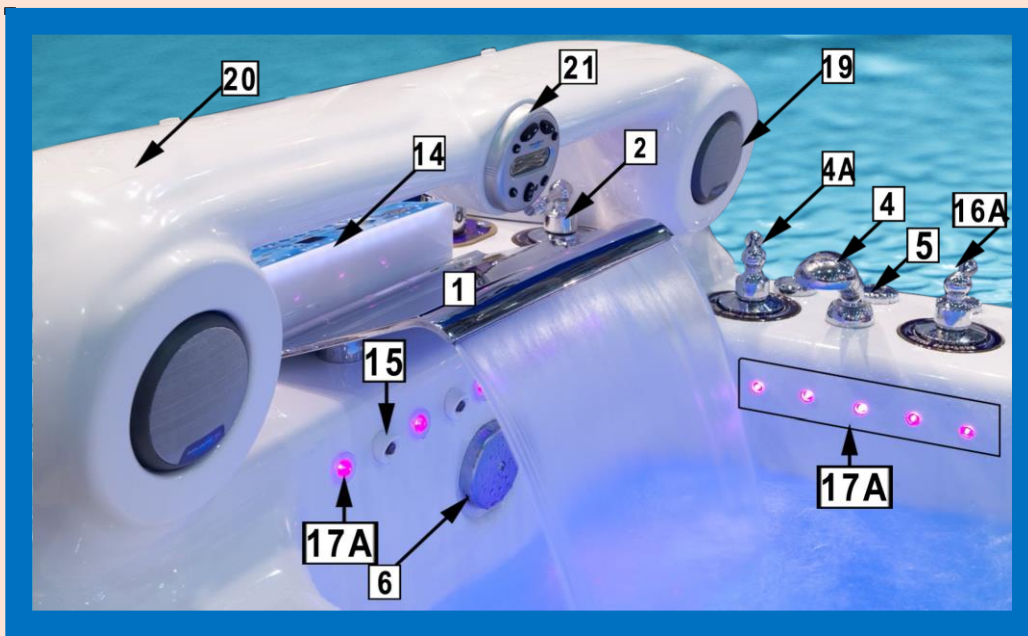

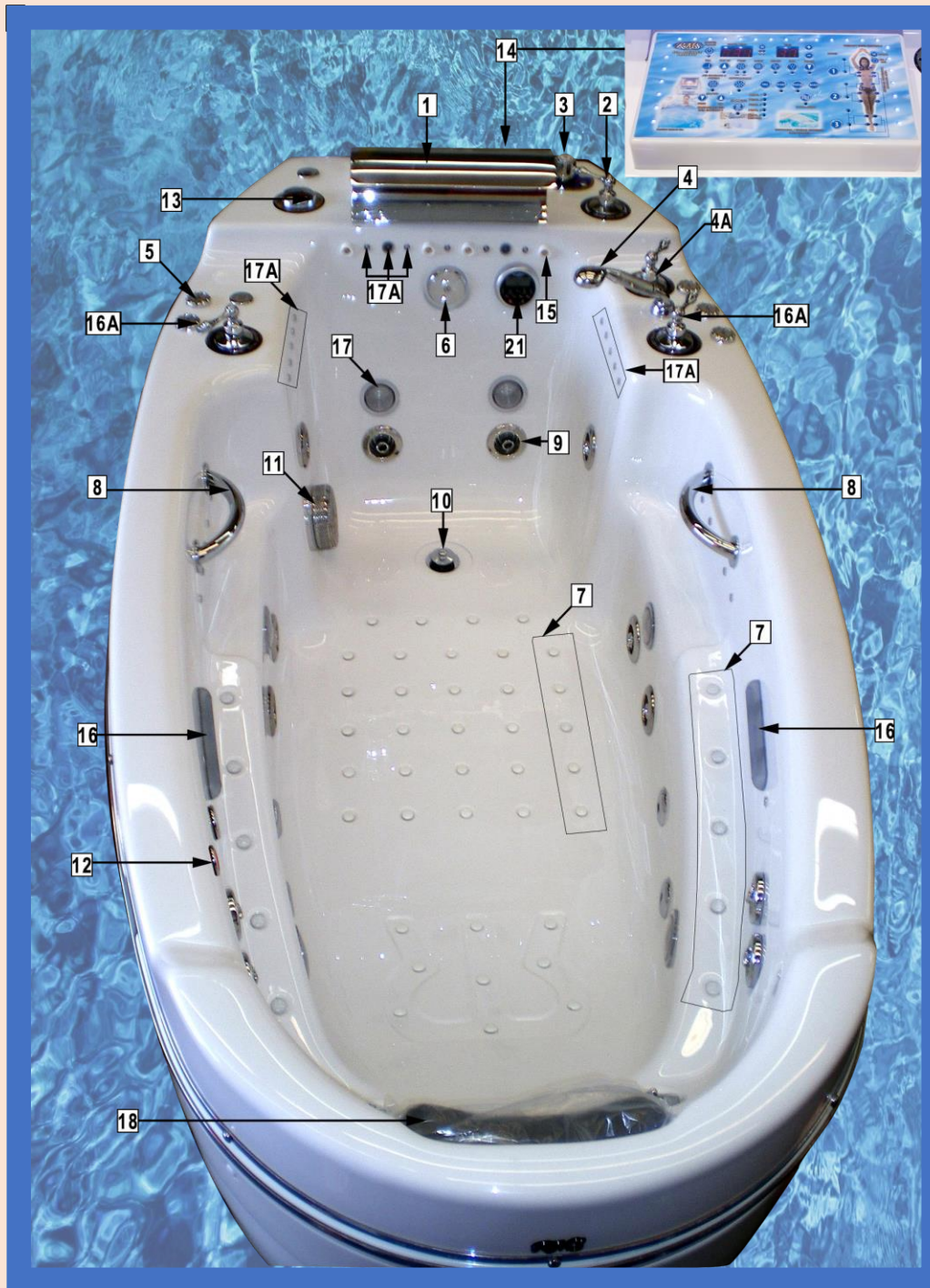
Luxury tub users and day spa operators looking for the best of both worlds





ENJOY SEVEN STAR SPA EXPERIENCE IN UPSCALE SPA RESORTS OR IN THE PRIVACY OF YOUR HOME





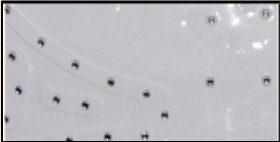















POS	PHOTO	DESCRIPTION
1		Fill spout. Special design, brass, chrome plated. Length: 14" (36cm) <i>NOTE: For model C-280 T Crystal Cove Limited Edition only.</i>
		Fill spout. Special design, brass, chrome plated. Length: 15" (40cm) <i>NOTE: For models C-280 T Crystal Cove and C-280 T MA-08 Sea Breeze</i>
2		Main shut-off valve. Use this valve to fill the tub with water.
3		Automatic water mixing system. Use this system to set a desired water temperature for your tub.
4		Hand shower for rinsing and cleaning.
4A		Hand shower shut-off valve.
5		Individual Air Controls for Therapy Zones Venturi System (Air Massage)

POS	PHOTO	DESCRIPTION
6		Overflow device
7		Air Jets. Anatomically placed air massage / aromatherapy jets (total 48pcs/240 air channels)
8		Grab bars
9		Anatomically placed adjustable jets (total 18 pcs). Jets are mounted in special recessed notches to avoid contact with bather's body.
10		Drain
11		Suction
12		Located within bather's reach at right hand side of the tub. When "PANIC" button is activated by bather all tub operations will be "frozen" without cancelling preset timer. Both displays will read: "PANIC". To reactivate tub operations press "START" on spa Topside control. <i>Use if necessary.</i>

POS	PHOTO	DESCRIPTION
13		<p>Integrated aromatherapy system through air bubble massage system. The following aroma beads cartridges are used in the system: Lavender, Sage, Eucalyptus, Tangerine. AC-04 Set of 4 Cartridges - standard,</p> <p>OPTION: AC-04 Set of 4 cartridges, different scents.</p> 
14		<p>Advanced, user-friendly electronic control with perimeter lights.</p>
15	<p>"Tropical Mist" - innovative invigorating Fog System with adjustable temperature feature, an excellent preparation for all kinds of facial treatments. A warm clean draw of moisture rich air causes pores to expand and stimulates blood circulation. <i>NOTE: For Crystal Cove LE and Crystal Cove models only. Option for Sea Breeze model.</i></p>	
16		<p>Side Rail/Crystalfalls/Chest & Belly Massage System with electronic control and individual intensity control valves. Set of 2.</p>
16A		<p>Side Rail/Crystalfalls shut-off valve.</p>
17		<p>Underwater lights/chromatherapy</p> <ul style="list-style-type: none"> *Crystal Cove LE * 6 underwater lights (24 LED each) *Crystal Cove * 6 underwater lights (9 LED each) *Sea Breeze * 6 underwater lights (9 LED each)

POS	PHOTO	DESCRIPTION
17A		<p>Extra-bright mini-lights, 3 LED each. Synchronized with underwater chromatherapy system.</p> <p>*Crystal Cove LE: 31 mini-lights around waterfalls 6 mini-lights in entertainment arch 24 mini lights in safety ladder. Total: 324 LED</p> <p>* Crystal Cove: 31 mini-lights around waterfalls 11 mini-lights in safety ladder</p> <p>* Sea Breeze: No mini-lights</p>
18		<p>Head support/pillow. Cushioned, removable</p>
19		<p>Speaker 25 W (for Crystal Cove LE only) NOTE: for detailed description of integrated splash protected entertainment center, please, see chapter 10 "System Operational Guide". Detailed instructions about entertainment center operation provided in a separate Entertainment Center Manual.</p>
20		<p>Entertainment Center Arch (for Crystal Cove LE model only)</p> <ul style="list-style-type: none"> * Equipped with two speakers 25 W each * 6 extra-bright mini-lights * Wired remote control with clock for the marine grade entertainment center * Main waterfall (see pos 1)
21		<p>Wired remote control with clock for the marine grade entertainment center (for Crystal Cove LE and Crystal Cove models)</p>

POS	PHOTO	DESCRIPTION
1		<p>AC-04-OP Set of aroma cartridges (4pcs), different scents.</p>
2		<p>#1 Underwater massage hose/hand wand/adjustable pressure, individual shut-off valve, pressure/temperature gauge, and special holder. See details in: CHAPTER 4 “OPTIONS FOR ALL JUMBO LINE MODELS.”</p> <p>#2 Underwater massage hose/hand wand/ <i>with easy-lock system</i>. equipped with individual shut-off valve, pressure / temperature gauge, and special holder. easy lock system allows user to easy connect / disconnect underwater massage hose without splashes.</p>
3		<p>Hydrotop® Extra-Comfort. Within less than one minute, any therapist can easily install the 2-segment Hydrotop® on a tub, converting it into a self-draining wet table with a specially mold head support, mattress pad, and a comfortable face opening. See details in: CHAPTER 4 “OPTIONS FOR ALL JUMBO LINE MODELS.”</p>
4		<p>SSL-01L Safety Ladder, 1 step. Equipped with soft, pebble-type mat and 11 extra-bright mini-lights. <i>NOTE: For Sea Breeze model only.</i></p>
5		<p>SSL-01S Safety Ladder, 1 step. Equipped with soft, pebble-type mat. No mini-lights. <i>NOTE: For Sea Breeze model only.</i></p>

- 6 Special Fog System “Tropical Mist” - innovative invigorating Fog System with adjustable temperature the feature, excellent preparation for all kinds of facial treatments. A warm, clean draw of moisture-rich air causes pores to expand and stimulates blood circulation. *NOTE: For Sea Breeze model only.*
- 7 RMSINTELLI Levels 2 through 6.
NOTE: RMSINTELLI LEVEL 1 the RMSINTELLIPACK is a standard feature for C-280T Crystal Cove Limited Edition, C-280 T Crystal Cove and C-280 T Sea Breeze.



SAMPLES OF TUB NAMEPLATES AND SERIAL NUMBERS.

APP. SHIPPING DIMENSIONS & WEIGHT (CRATED)				
MODEL	DIMS. INCHES	DIMS. CM	WGHT LBS	WGHT. KG
C-280T MA-08 CRYSTAL COVE LIMITED EDITION	96" (L) x 49" (W) x 53" (H)	244cm (L) x 124cm (W) x 135cm	app.919	app. 417
C-280T MA-08 CRYSTAL COVE	96" (L) x 49" (W) x 49" (H)	244cm (L) x 124cm (W)	app. 874	app. 397
C-280T MA-08 SEA BREEZE	96" (L) x 49" (W) x 49" (H)	244cm (L) x 124cm (W)	app. 693	app. 315
C-280 T MB-08 SEA CORAL	96" (L) x 49" (W) x 48" (H)	244cm (L) x 124cm (W) x 122cm	app. 593	app. 270
C-280 T MC-08/S "SEABAY SPA,"	96" (L) x 49" (W) x 46" (H)	244cm (L) x 124cm (W) x 116cm	app. 563	app. 256
C-280 T MC-08/O "OCEAN FLOWER"	96" (L) x 49" (W) x 46" (H)	244cm (L) x 124cm (W) x 116cm	app. 533	app. 242

**JUMBO LINE INTELLI-TUB®(S),
C-280T MA-08 "CRYSTAL COVE LIMITED EDITION."
(CC LE)**



90" (2290mm.)

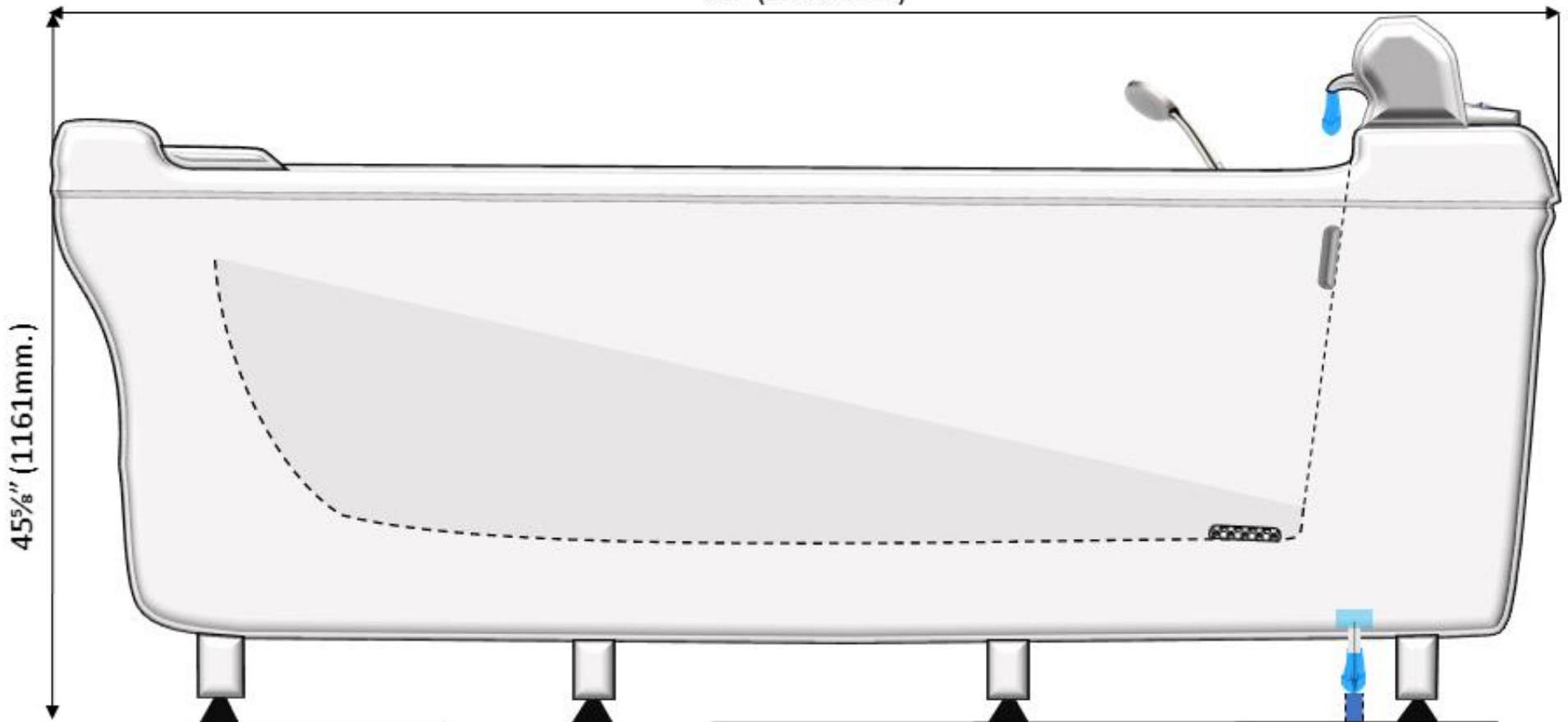

**JUMBO LINE INTELLI-TUB®(S),
C-280T MA-08 “CRYSTAL COVE,” “SEABREEZE,”
C-280 T MC-08/S “SEABAY SPA,”
C-280 T MC-08/O “OCEAN FLOWER”**



90" (2290mm.)

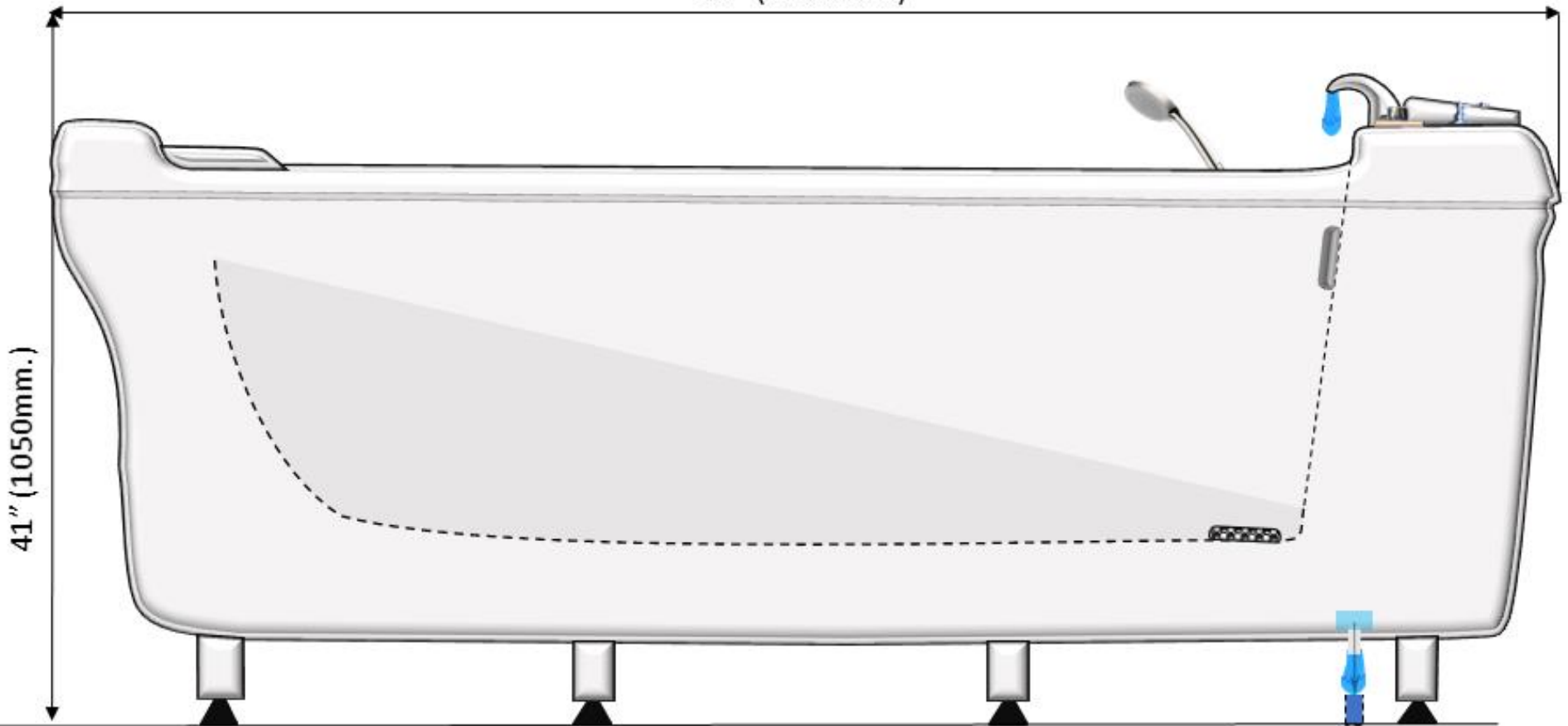

41" (1050mm.)

C-280T MA-08 "SEA BREEZE"



**JUMBO LINE SPA
INTELLI-TUB®**



C-280T MA-08
"CRYSTAL COVE LIMITED EDITION."



JUMBO LINE SPA INTELLI-TUB®

C-280T MA-08 "CRYSTAL COVE"



JUMBO LINE SPA
INTELLI-TUB®

JUMBO LINE SPA INTELLI-TUB®



C-280T MA-08
"CRYSTAL COVE LIMITED EDITION."

C-280T MA-08 "SEA BREEZE."

JUMBO LINE SPA INTELLI-TUB®





C-280T MA-08 "CRYSTAL COVE"



C-280T MA-08 "SEA BREEZE."



JUMBO LINE SPA INTELLI-TUB®



C-280T MA-08
"SEA BREEZE"



**JUMBO LINE SPA
INTELLI-TUB®**

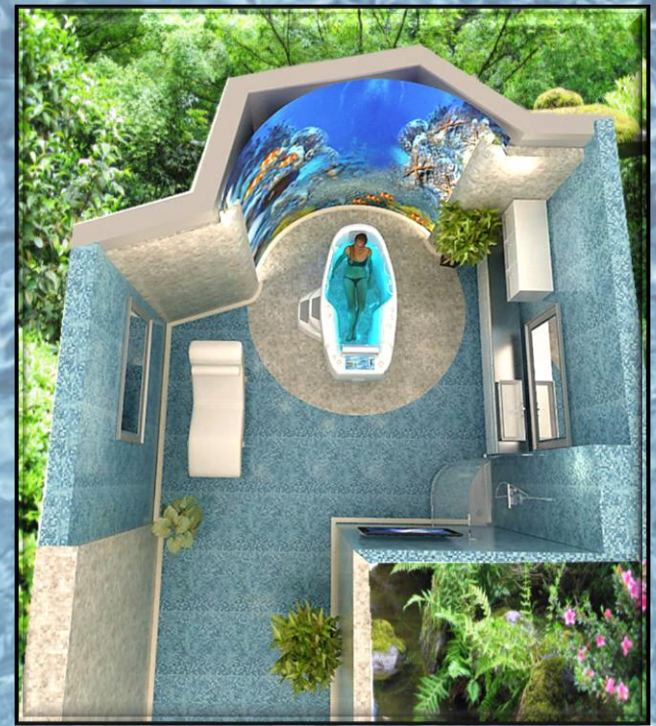

C-280T MA-08 "SEA BREEZE."



**JUMBO LINE SPA
INTELLI-TUB®**

C-280T MA-08 "SEA BREEZE."

**JUMBO LINE SPA
INTELLI-TUB®**



C-280T MA-08 "SEA BREEZE."

JUMBO LINE SPA
INTELLI-TUB®



JUMBO LINE SPA
RMS[®]
INTELLI-TUB[®]



C-280T MA-08
"CRYSTAL COVE LIMITED EDITION."



C-280T MA-08
"CRYSTAL COVE LIMITED EDITION."



JUMBO LINE SPA
RMS[®]
INTELLI-TUB[®]

C-280T MA-08
"CRYSTAL COVE LIMITED EDITION."



C-280T MA-08 "CRYSTAL COVE"

JUMBO LINE SPA
INTELLI-TUB®



**NOTE: SOME TUBS MAY BE SHOWN WITH OPTIONS.
SEE SPECIFICATIONS FOR DETAILED TUB DESCRIPTION.**

**JUMBO LINE SPA
C-280T MA-08 "OCEAN FLOWER."**



**NOTE: SOME TUBS MAY BE SHOWN WITH OPTIONS.
SEE SPECIFICATIONS FOR DETAILED TUB DESCRIPTION.**



**JUMBO LINE SPA
C-280T MA-08 "SEACORAL."**



**JUMBO LINE SPA
C-280T MA-08 "SEACORAL."**



**JUMBO LINE SPA
C-280T MA-08 "SEABAY SPA."**



**JUMBO LINE SPA
C-280T MA-08 "OCEAN FLOWER."**

FULLY AUTOMATIC ELECTRONIC CONTROL

To turn the unusual into the remarkable RMS added all new user-friendly easy touch control panel. Easy-to-use control minimizes time and efforts to operate the tub. No more messy submenus and complicated computer screens! RMS **Intelli-tub** does everything for you!



JUST PRESS THE BUTTON AND ENJOY!

RMS

JUMBO LINE SPA INTELLI-TUB®

WORLD CLASS TECHNICAL SUPPORT



At RMS, we believe our success is best measured by your success, which is why we have created a line of spa equipment dedicated to keeping you at your best

At RMS, we are committed to excellent technical support and customer service

These include email and call center support, a robust knowledge base, complete documentation, and more. Technical questions are answered in fast, professional and courteous manner

Most of technical information is provided in RMS Installation Guidelines, available upon request or on RMS website

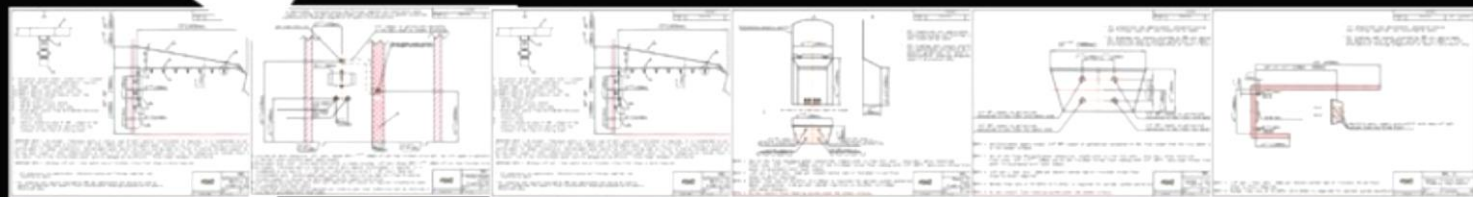

JUMBO LINE SPA INTELLI-TUB®

**JUMBO LINE.
MODEL C-280 T MA-08 CRYSTAL COVE LIMITED EDITION INTELLI-TUB®**



MOVING EQUIPMENT ON-SITE.

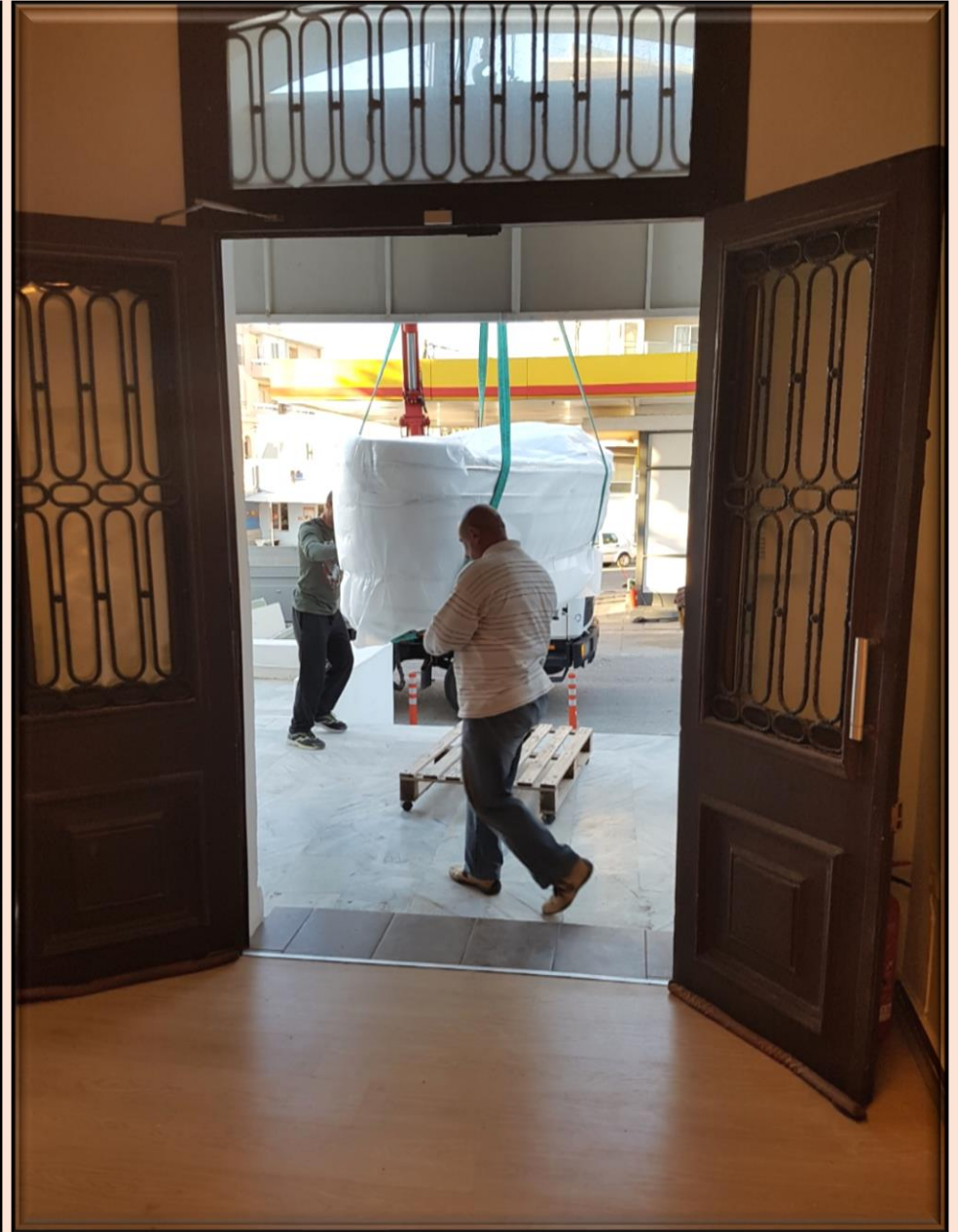

CHAPTER 2. LAYOUTS, WET ROOM SPA PACKAGES, EXAMPLES OF INSTALLATION.

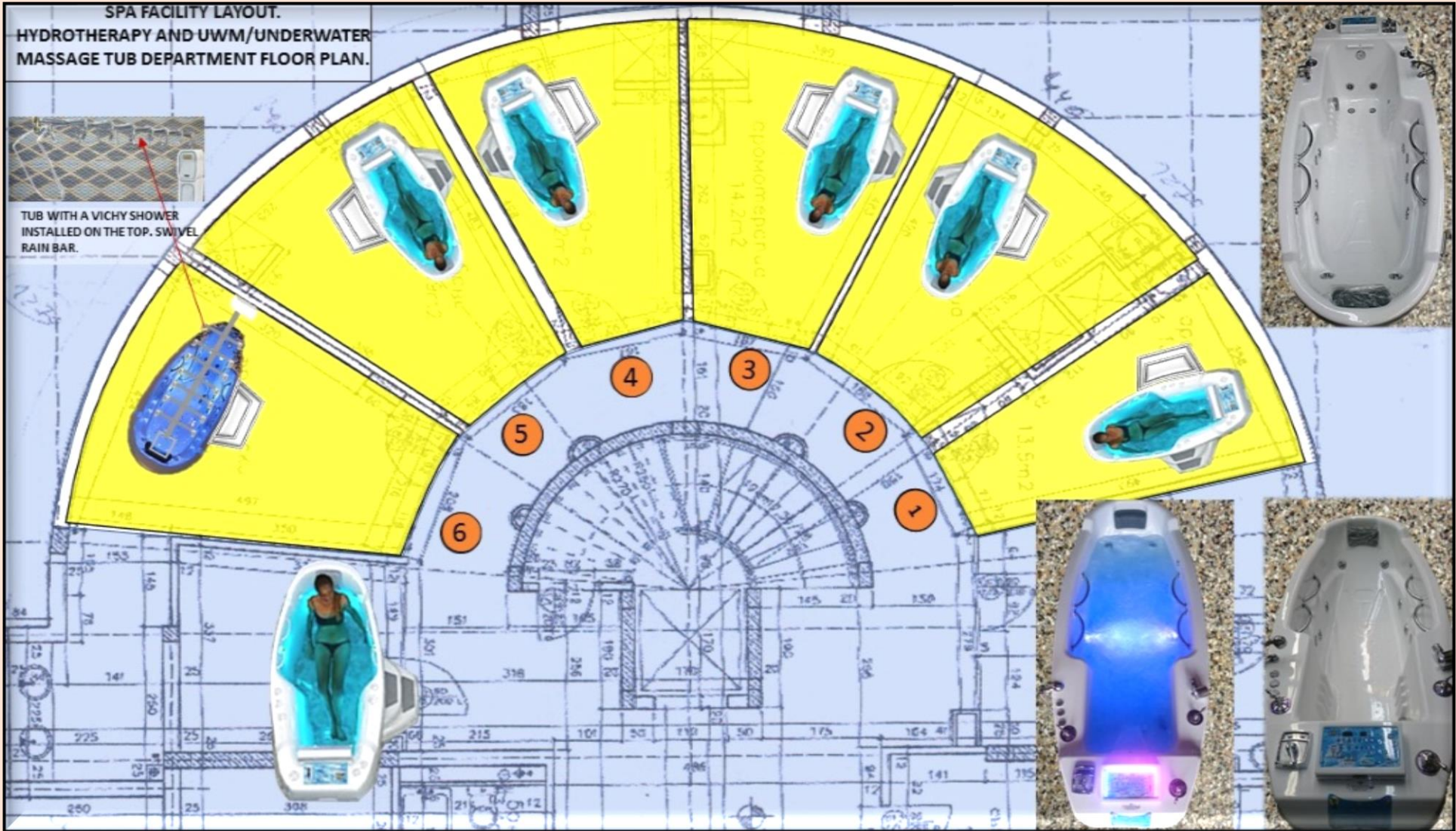

SPA ROOM LAYOUT. TUB #1 FLOOR PLANS. ROOM 146 SQ.FT (13.5 M²)

FLOOR PLAN #1

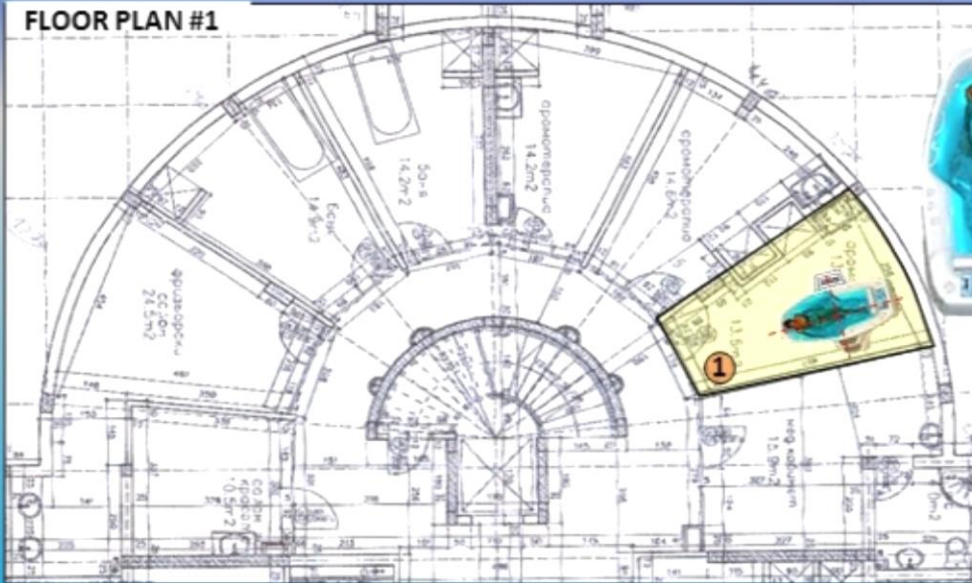

FLOOR PLAN #2

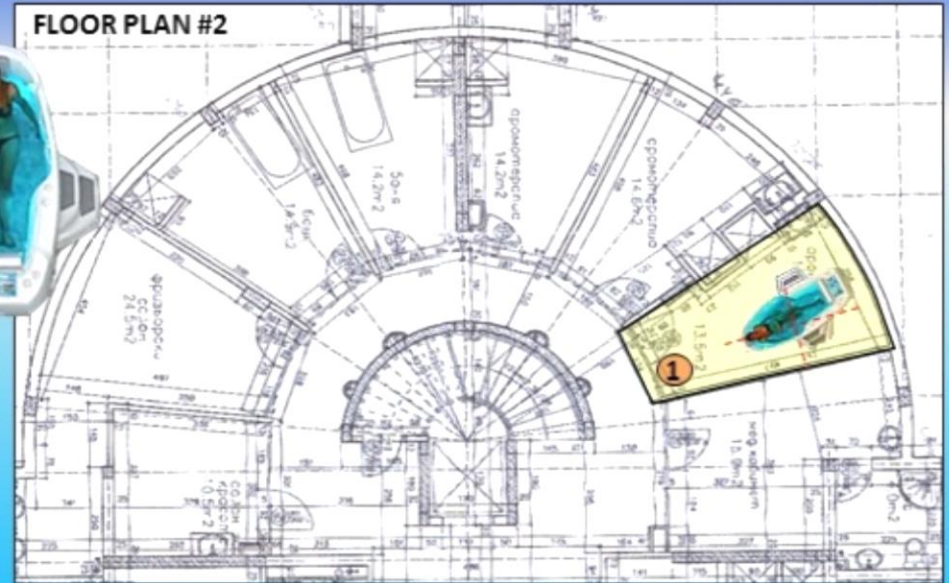

FLOOR PLAN #3

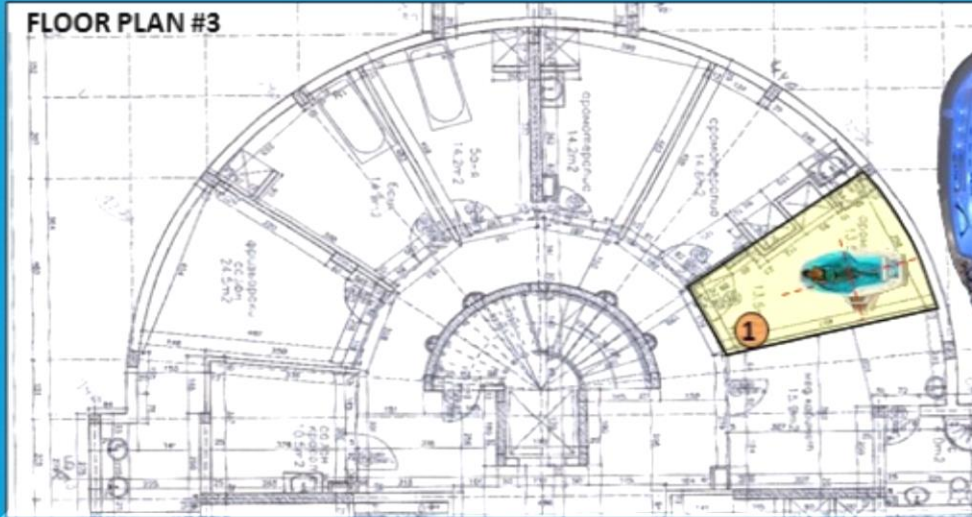

FLOOR PLAN #4

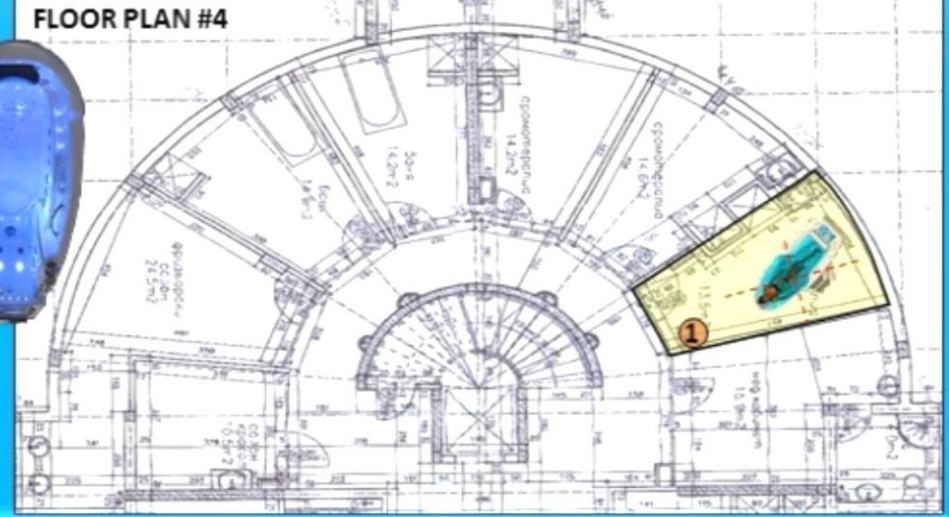

TUB #1 TOP/FRONT VIEW.

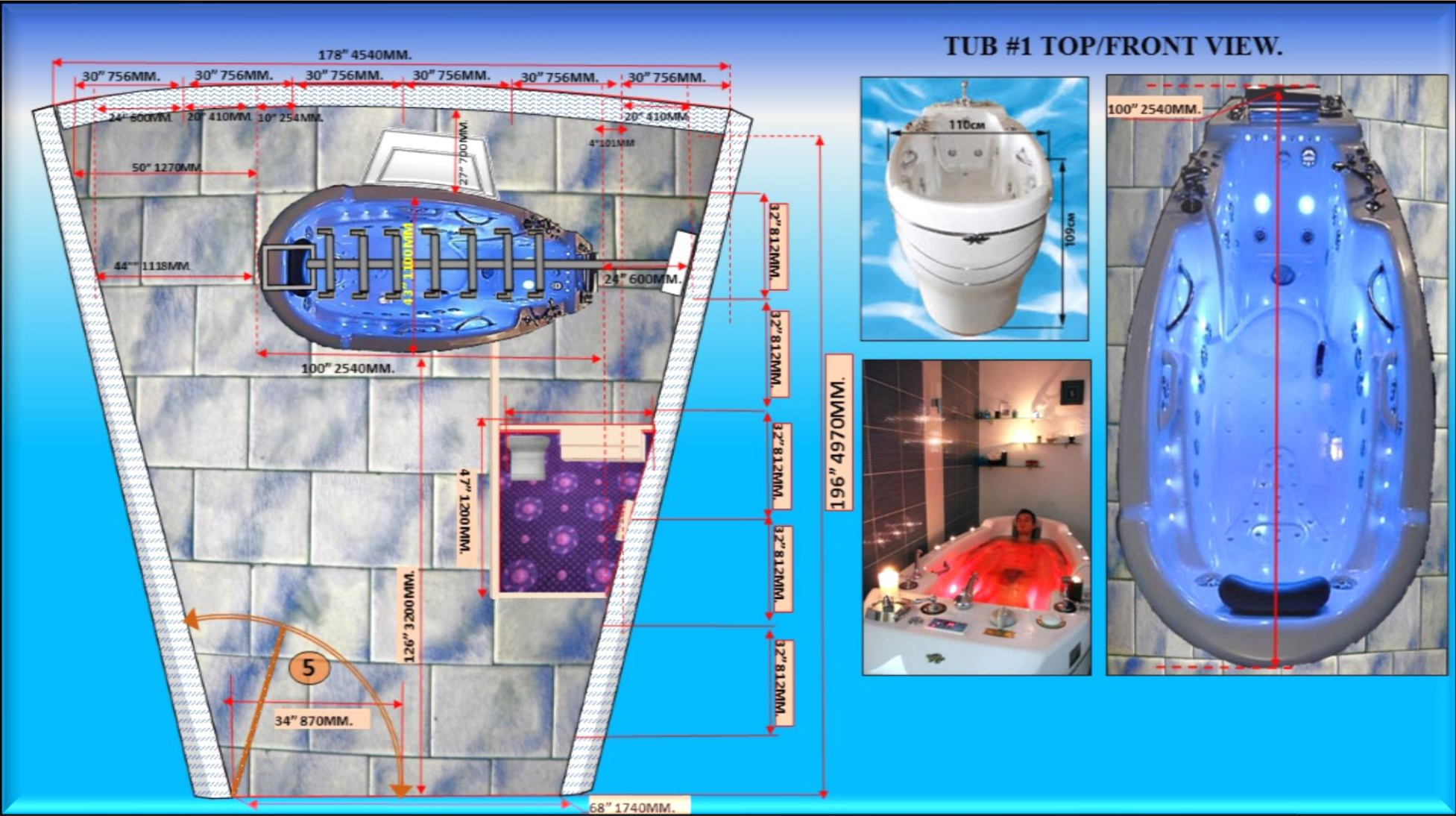

PLUMBING/ELECTRICAL REQUIREMENTS. JUMBO LINE TUBS (ALL MODELS).

PLUMBING/ELECTRICAL REQUIREMENTS:

1. Cold water connection: 3/4" MPT, 1" 25mm. above the tiled floor..
 2. Hot water connection: 3/4" MPT, 1" 25mm. above the tiled floor.
 3. Electrical floor connection (N. AMERICA, INTERNATIONAL):
220V/60/50Hz (L1/N/SL) 15 Amps, max. 3.6 KW
 4. Main floor drain with odor trap: diam. 70/100mm and an additional side inlet 50mm, used as an auxiliary room drain simultaneously with the main drain.
- * Recommended type of main drain connection is by air gap means.
 - * Minimum door width for installation: 1100mm.
 - * Tub weight: app. 850lbs/386kgs.



**PLUMBING AND ELECTRICAL REQUIREMENTS.
JUMBO LINE SERIES. INTELLI-TUB®,**

EXAMPLE OF RECOMMENDED PLUMBING DIAGRAM FOR PROFESSIONAL SPA SHOWER ROOMS.

SPECIAL NOTE!!!

WE RECOMMEND TO INSTRUCT YOUR SPA DESIGNER/CONTRACTOR TO INDICATE IN WRITING THAT WHEN ALL PLUMBING IS DONE, THEY MAKE CONCRETE SUBFLOOR (BEFORE TILING) WITH A SLOPE TOWARDS DRAINS. MIN. SLOPE REQUIRED ¼" PER LINEAR FOOT, WHICH IS ABOUT 2CM. PER ONE METER. THE TILERS MUST FOLLOW THIS SLOPE.

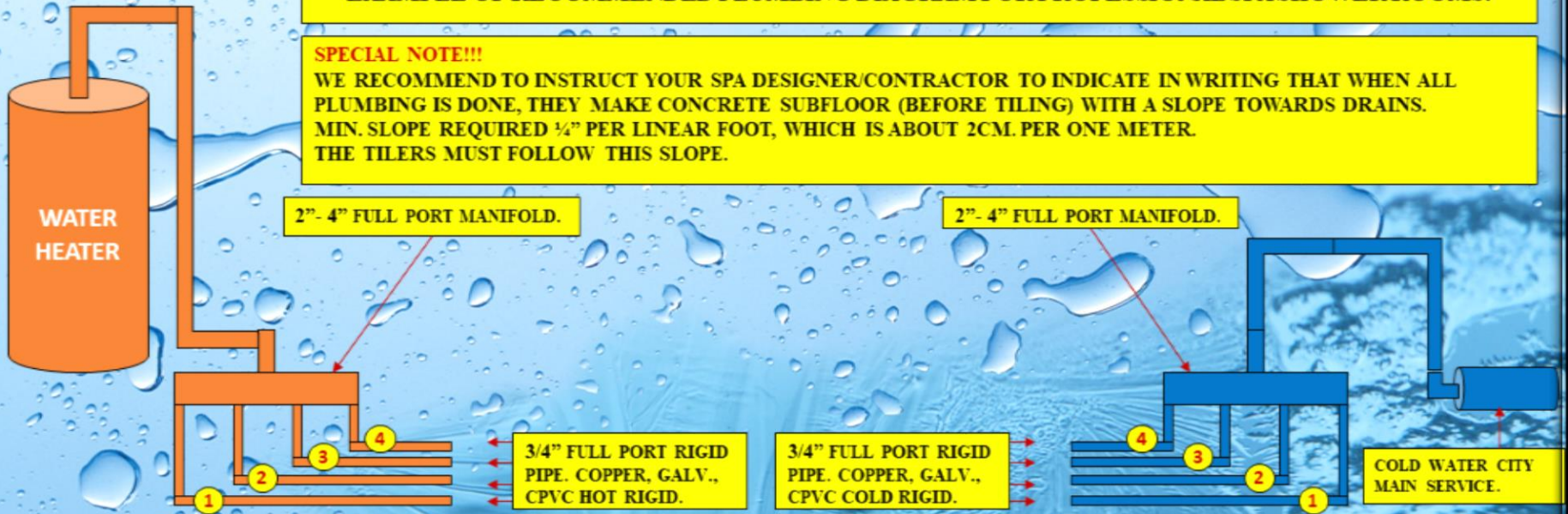

- 1. VICHY (AUTOMATIC TEMPCONTROL.) HOT WATER
- 2. TRIBUNE "A" HOT WATER #1
- 3. TRIBUNE "A" HOT WATER #2
- 4. TUB HOT WATER

NOTE!!! 3/4" FULL PORT SHUT OFF VALVE INSTALLATION RECOMMENDED ON EACH WATERLINE.

- 1. VICHY (AUTOMATIC TEMPCONTROL.) COLD WATER
- 2. TRIBUNE "A" COLD WATER #1
- 3. TRIBUNE "A" COLD WATER #2
- 4. TUB COLD WATER.

NOTE!!! 3/4" FULL PORT SHUT OFF VALVE INSTALLATION RECOMMENDED ON EACH WATERLINE.

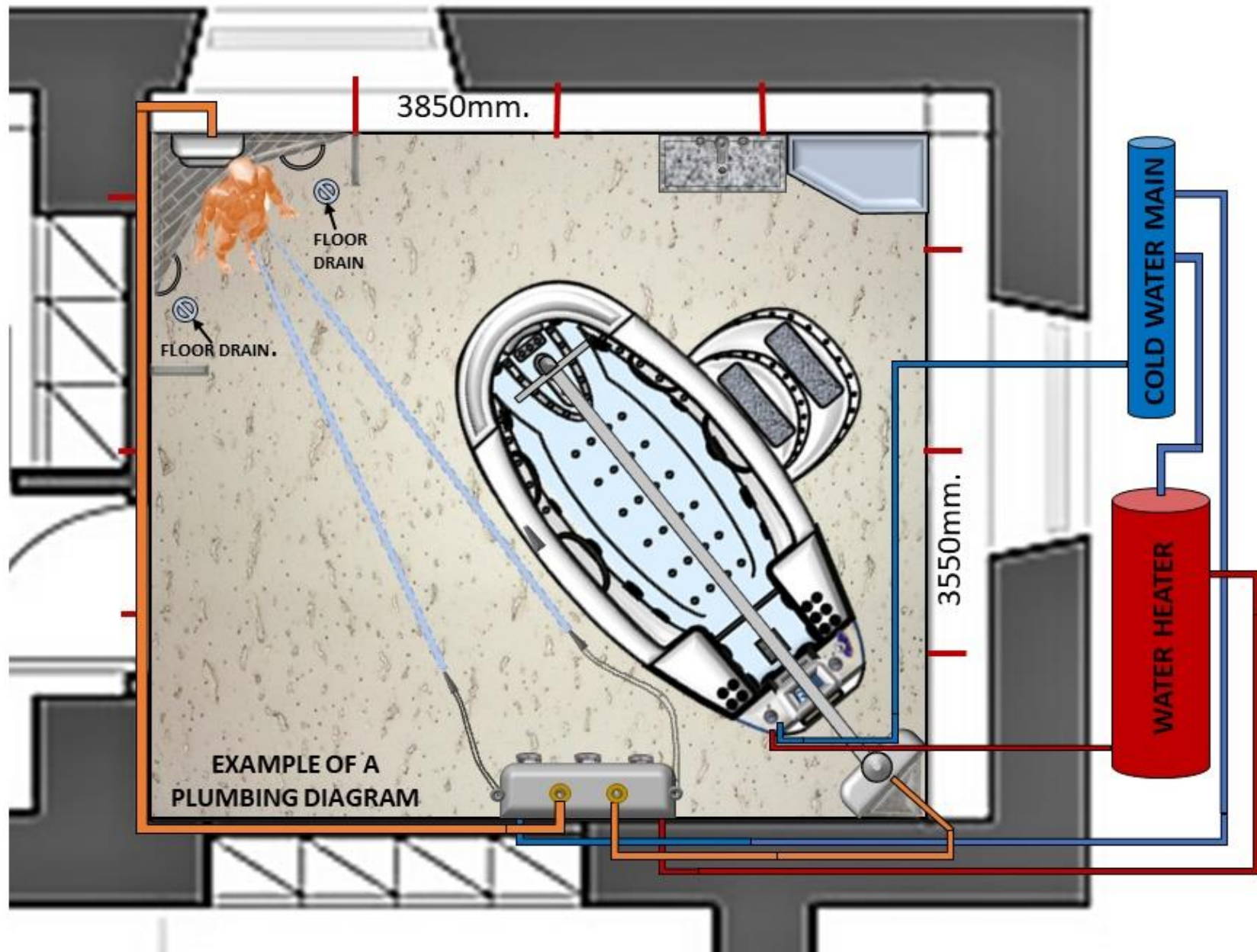

RMS® PLUMBING DIAGRAM FOR RMS® PROFESSIONAL HYDROTHERAPY TUBS.

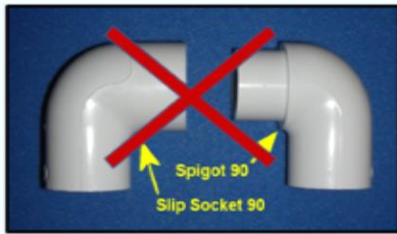

IF ANY TYPE OF THICK WALL PLASTIC PIPES IS USED, SIZE IT UP TO AVOID SIGNIFICANT PIPE ID REDUCTION WHICH WOULD NOT PROVIDE ENOUGH WATER FLOW FOR THE SYSTEM. DO NOT USE ANY TYPES OF SPIGOT FITTINGS WHICH ARE INSTALLED INSIDE THE PIPE PORT REDUCING THE INTERNAL PIPE DIAMETER AND WATER FLOW CORRESPONDINGLY.

M
A
I
N
C
O
L
D
W
A
T
E
R

CITY WATER SERVICE/MAIN COLD WATER PIPE

RECOMMENDED TYPES OF PIPES.

3/4" RIGID GALVANIZED, CPVC APPROVED FOR HOT WATER.
3/4" RIGID COPPER OR 3/4 RIGID SS PIPES RECOMMENDED.

WARNING! ALWAYS RUN DEDICATED WATER LINES.

3/4" CONNECTION HOSES PROVIDED.

> SEE INSTRUCTION MANUALS FOR ADDITIONAL INFORMATION

#2
3/4" DEDICATED COLD WATER PIPE.

WATER HEATER

3/4" DEDICATED HOT WATER PIPE.

#1 3/4" DEDICATED COLD WATER PIPE.

3/4" COLD WATER PIPE

FLOOR

FLOOR

FLOOR DRAIN 2" 50MM

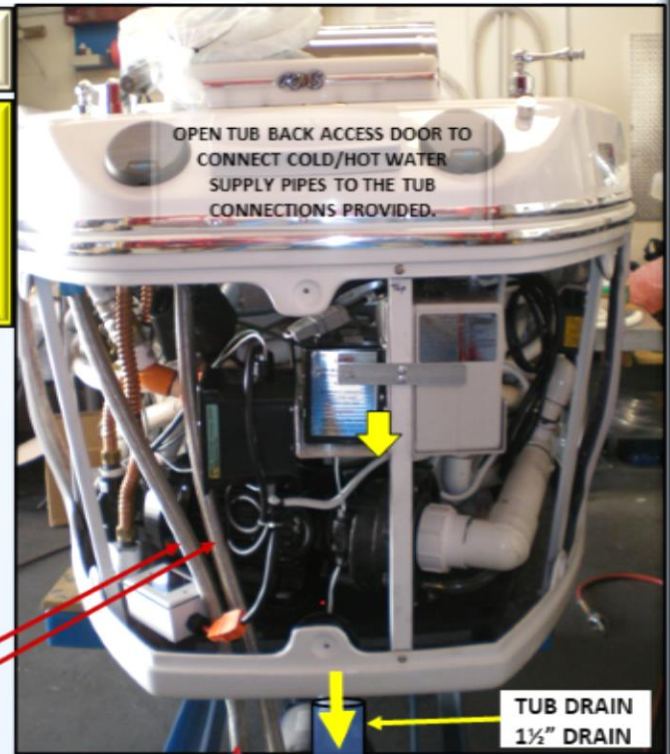

TUB DRAIN
1 1/2" DRAIN

2" FLOOR DRAIN



ELECTRICAL DIAGRAM.

**RMS® PROFESSIONAL HYDROTHERAPY TUBS.
JUMBO LINE INTELLI-TUB® (ALL MODELS)**



➤ **SEE INSTRUCTION MANUALS
FOR ADDITIONAL
INFORMATION.**

**WALL MAIN-BREAKER
INDOOR ELECTRICAL-
PANEL BOX.**

**DEDICATED LINE 220/60/50Hz, 1
PHASE, GAUGE №10, 15AMP. DRY
AND WET TYPE APP. 50" (1200MM)**

TUB JUNCTION BOX

15A 1PH, GAUGE №10

15A 1PH, GAUGE №10

**OPEN FRONT ACCESS DOOR TO CONNECT ELECTRICAL
POWER CABLE TO THE TUB JUNCTION BOX TERMINAL
CONNECTIONS PROVIDED.**

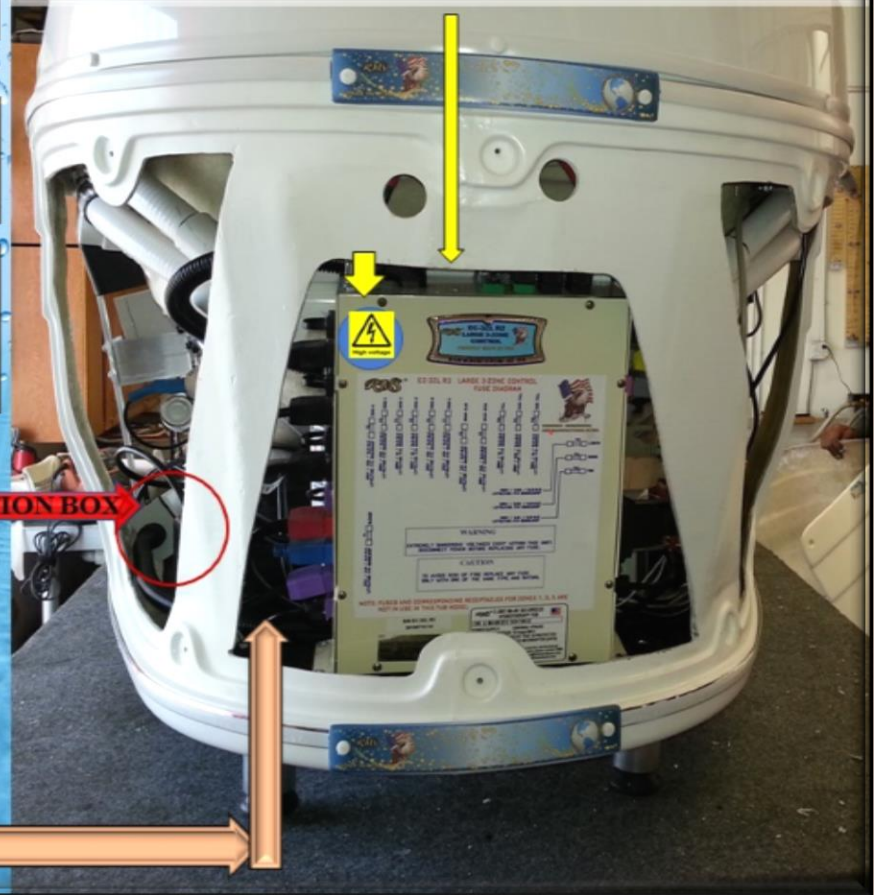

ELECTRICAL REQUIREMENTS.

IMPORTANT NOTE:

IT IS EXTREMELY IMPORTANT THAT THE PROPER VOLTAGE BE PRESENT. A VOLTAGE OF 230V IS IDEAL. IF YOUR VOLTAGE READING IS LESS THAN 208V IT IS POSSIBLE THAT THE ELECTRICAL EQUIPMENT WILL NO FUNCTION PROPERLY. IF YOUR VOLTAGE IS 208V OR LOWER, RMS® HIGHLY RECOMMENDS A TRANSFORMER BE INSTALLED TO BRING THE VOLTAGE TO 230V. HOWEVER, IF RAISED THIS LINE VOLTAGE CANNOT BE OVER 245V. IN-LINE "BUCK-BOOSTER" TRANSFORMERS ARE RELATIVELY INEXPENSIVE AND WORK VERY WELL.

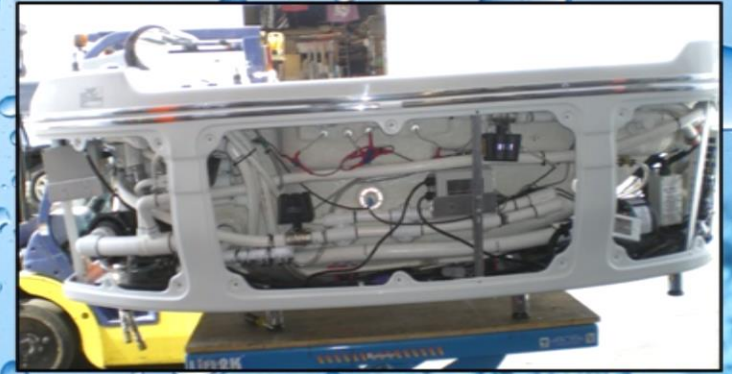



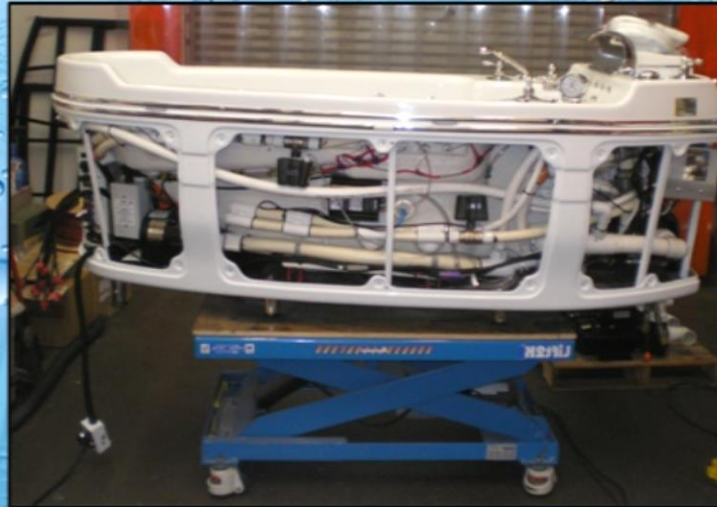
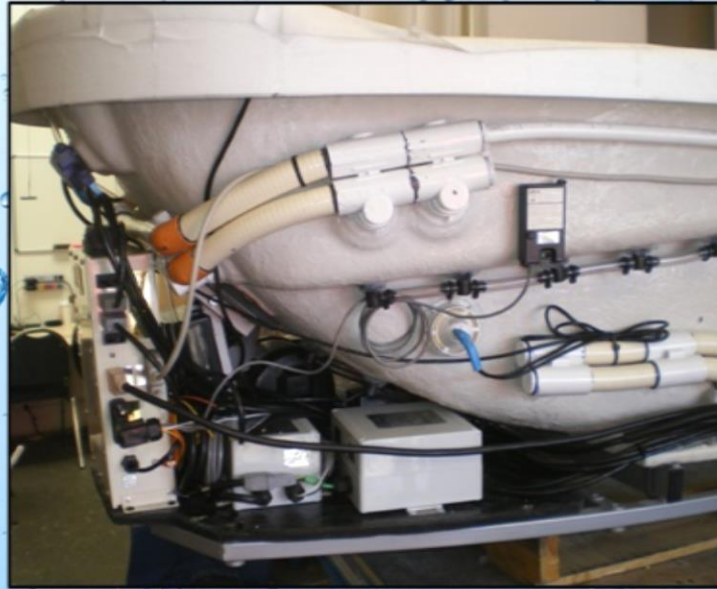

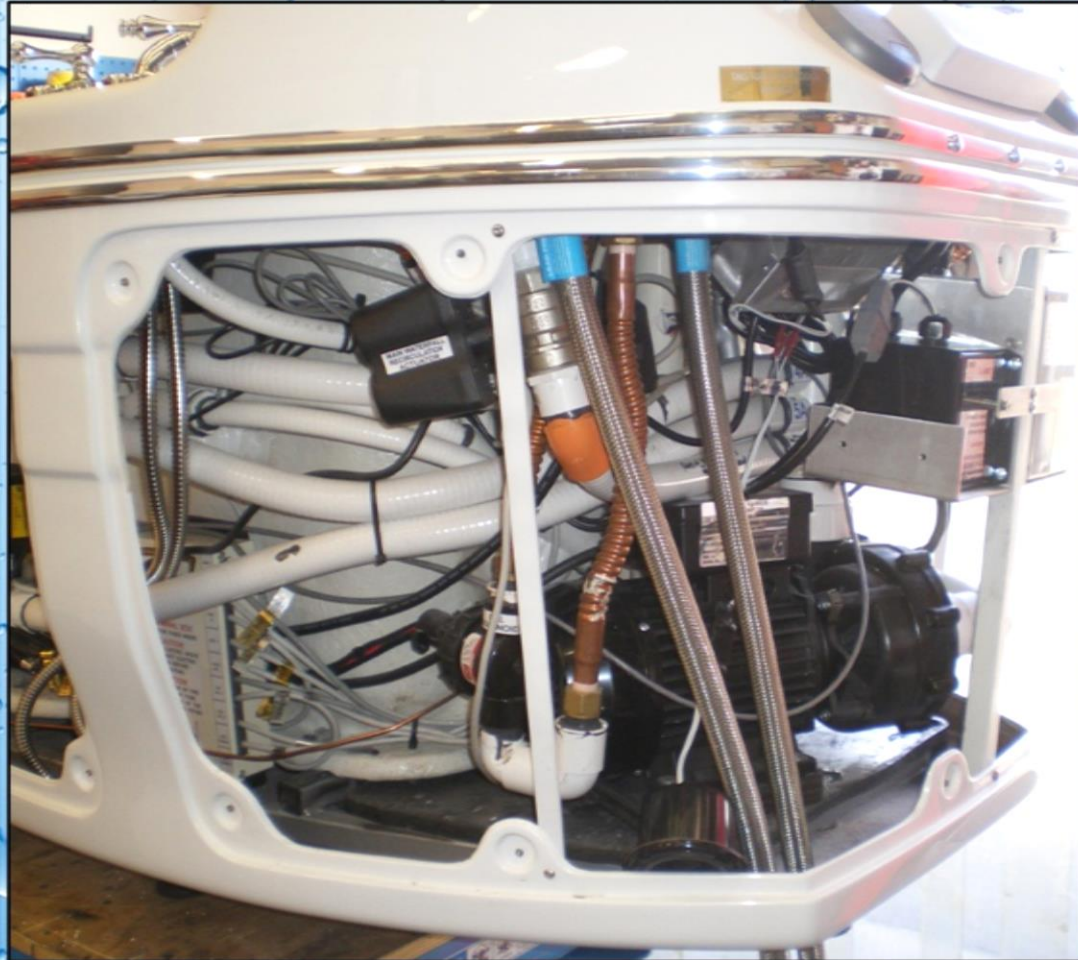



RMS® PLUMBING AND ELECTRICAL REQUIREMENTS FOR RMS® PROFESSIONAL HYDROTHERAPY TUBS JUMBO LINE, TR-320 MB JL.

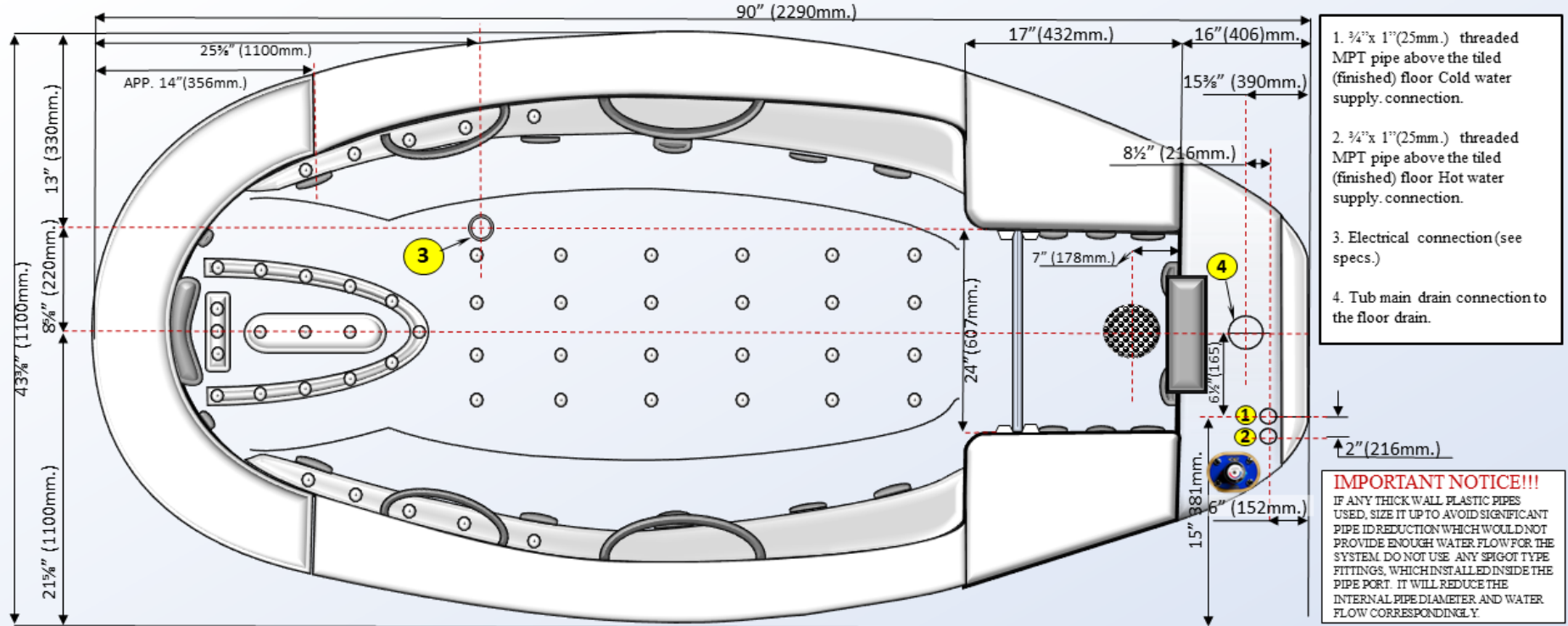

NORTH AMERICA, TWO PHASE. NORTH AMERICA MODELS ONLY FOR USE WITH U.S. 240V, 60HZ, SUPPLY - TWO PHASES EACH OF 120V TO GROUND)
NORTH AMERICA, TWO PHASE.
TERMINAL MARKED "L1" = LIVE 1
TERMINAL MARKED "L2" = LIVE 2
GROUND BUSSBAR/LUG MARKED "GROUND/SL" = GROUND
VOLTAGE 240V, CURRENT 15A L1/L2SL
FREQUENCY 60Hz, PHASES 2
CABLE #10AWG (5.3MM²) 3-WIRE DRY AND WATER RESISTANT CABLE COPPER STRANDED WIRES, 700MM.

-INTERNATIONAL, SINGLE PHASE.
-TERMINAL MARKED "L1" = LIVE (PHASE)
-TERMINAL MARKED "N" = NEUTRAL
-GROUND BUSSBAR/LUG MARKED "GROUND/SL" = EARTH/GROUND
-VOLTAGE 240V
-CURRENT 15A L1/N/SL
-FREQUENCY 50Hz
-PHASES 1
-CABLE #10AWG (5.3MM²) 3-WIRE DRY AND WATER-RESISTANT CABLE COPPER STRANDED WIRES, 700MM.

THE BRANCH CIRCUIT SUPPLYING THIS SYSTEM MUST BE:
-PROVIDED WITH ALL MAINS DISCONNECT ALL POLE AND PROTECTED BY A "CLASS A" DEDICATED GROUND FAULT CIRCUIT INTERRUPTER (GFCI) ALL POLE, INSTALLED, LOCATED AND MOUNTED IN ACCORDANCE WITH LOCAL AND NATIONAL ELECTRICAL CODES.
-NOMINAL FAULT CURRENT MAX. 30MA OUTSIDE OF NORTH AMERICA.
-A GFCI MAY BE REFERRED TO AS AN EARTH LEAKAGE CIRCUIT BREAKER. THE ELCB SHOULD HAVE A MAXIMUM OPERATING TRIP CURRENT OF 30MILLIAMPS.

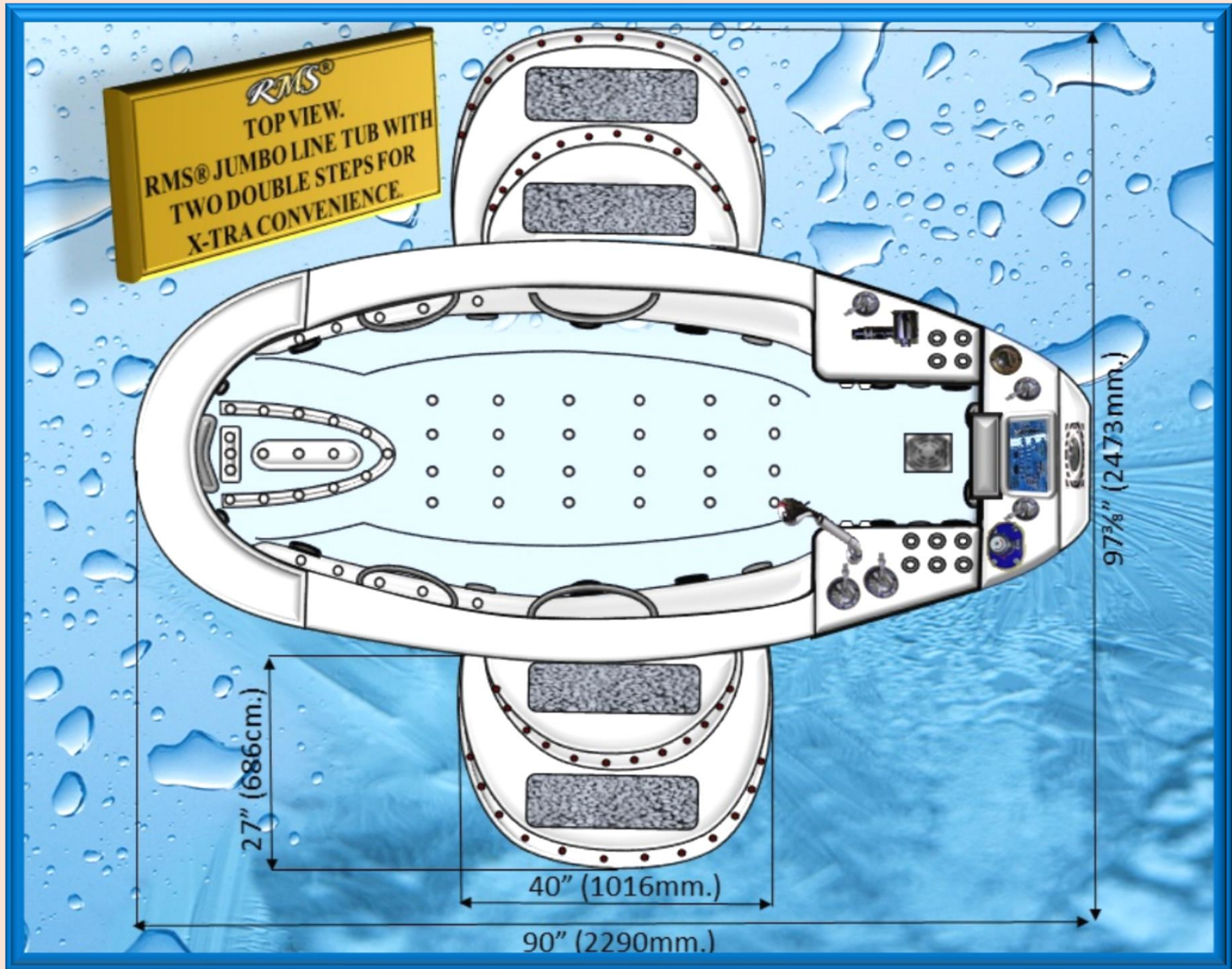



**PLUMBING/ELECTRICAL DIAGRAM FOR RMS® PROFESSIONAL HYDROTHERAPY TUBS.
JUMBO LINE (ALL MODELS), UWM TUB TR-320 MB-JL, L-105 JUMBO DE-LUXE.**

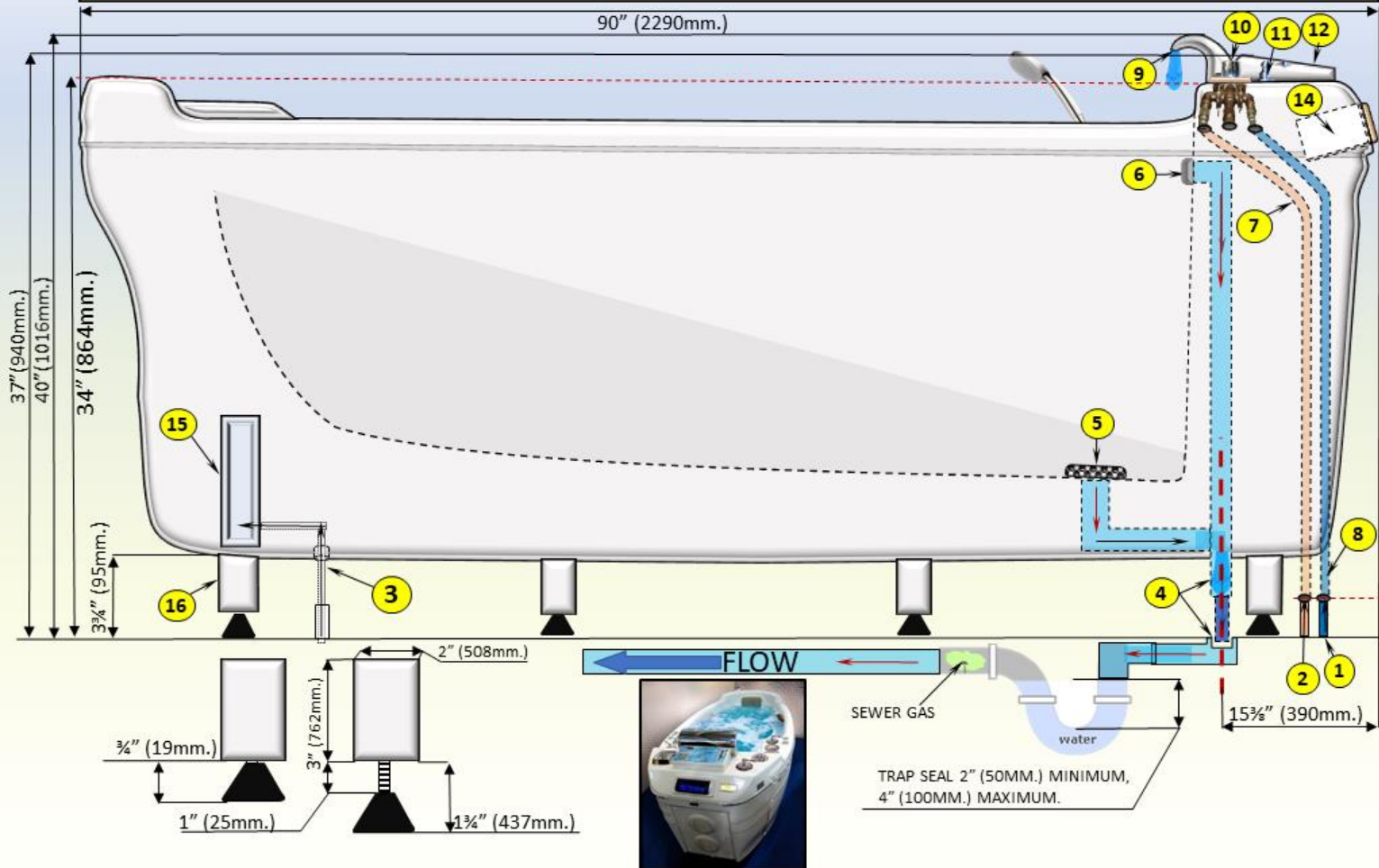

3/4" X 1" (25MM.) ABOVE
THE TILED FINISHED FLOOR
THREADED MPT PIPE
COLD/HOT WATER.

**TUB PLUMBING/ELECTRICAL DIAGRAM DESCRIPTION.
JUMBO LINE INTELLI-TUB®.**

#	FEATURE/PART DESCRIPTION	QTY	NOTES
1	¾"X 1" MPT (25MM.) ABOVE THE FINISHED FLOOR COLD WATER SUPPLY PIPE	1	
2	¾"X 1" MPT (25MM.) ABOVE THE FINISHED FLOOR HOT WATER SUPPLY PIPE	1	
3	3 WIRE ELECTRICAL SUPPLY CABLE 10 GAUGE X 3'(APP.900MM.)	1	TWO IF EQUIPPED WITH ADDITIONAL BOOSTER PUMP FOR UWM KIT (OPTIONAL)SEE INSTRUCTIONS FOR MORE DETAILS.
4	1½" TUB MAIN DRAIN TO FLOOR DRAIN TELESCOPIC CONNECTION.	1	PROFESSIONAL AIR GAP INSTALLATION RECOMMENDED
5	INSIDE THE TUB DRAIN FIXTURE.	1	CAN BE FULLY AUTOMATIC INTELLI DRAIN, SEMI AUTOMATIC OR MANUAL. DEPENDS ON THE TUB MODEL.
6	INSIDE THE TUB OVERFLOW FIXTURE.	1	
7-8	¾" X 36" (914MM.) HOT/COLD WATER CONNECTION BRAIDED OR S.S. FLEX WITH BACKFLOW PROTECTION DEVICE PROVIDED WITH THE TUB. HOSES HAVE A PIVOT NUT FOR QUICK HOOK UP.	2	
9	MAIN FILL/RECIRCULATION WATERFALL	1	TYPE AND SIZE DEPENDS ON THE TUB MODEL (SEE TUB SPECS)
10	AUTOMATIC TEMP CONTROL	1(IF APPLIES)	TYPE AND SIZE DEPENDS ON THE TUB MODEL (SEE TUB SPECS)
11	CONTROL VALVES		QTY DEPENDS ON THE TUB MODEL (SEE SPECS)
12	TOPSIDE CONTROL	1	TYPE AND MODEL DEPENDS ON THE TUB MODEL
13	N/A		
14	MARINE GRADE SPLASH PROTECTED ENTERTAINMENT CENTER	1(IF APPLIES)	TYPE AND MODEL DEPENDS ON THE TUB MODEL
15	MAIN ELECTRONIC CONTROL BOX	1	TYPE AND MODEL DEPENDS ON THE TUB MODEL
16	ADJUSTABLE FEET WITH ANTI VIBRATIONAL SYSTEM	8	

**PLUMBING AND ELECTRICAL REQUIREMENTS.
JUMBO LINE INTELLI-TUB®.**

PLUMBING/ELECTRICAL DIAGRAM FOR RMS® PROFESSIONAL HYDROTHERAPY TUBS. JUMBO JUMBO LINE (ALL MODELS), UWM TUB TR-320MB-JL, L-105 JUMBO DE-LUXE.

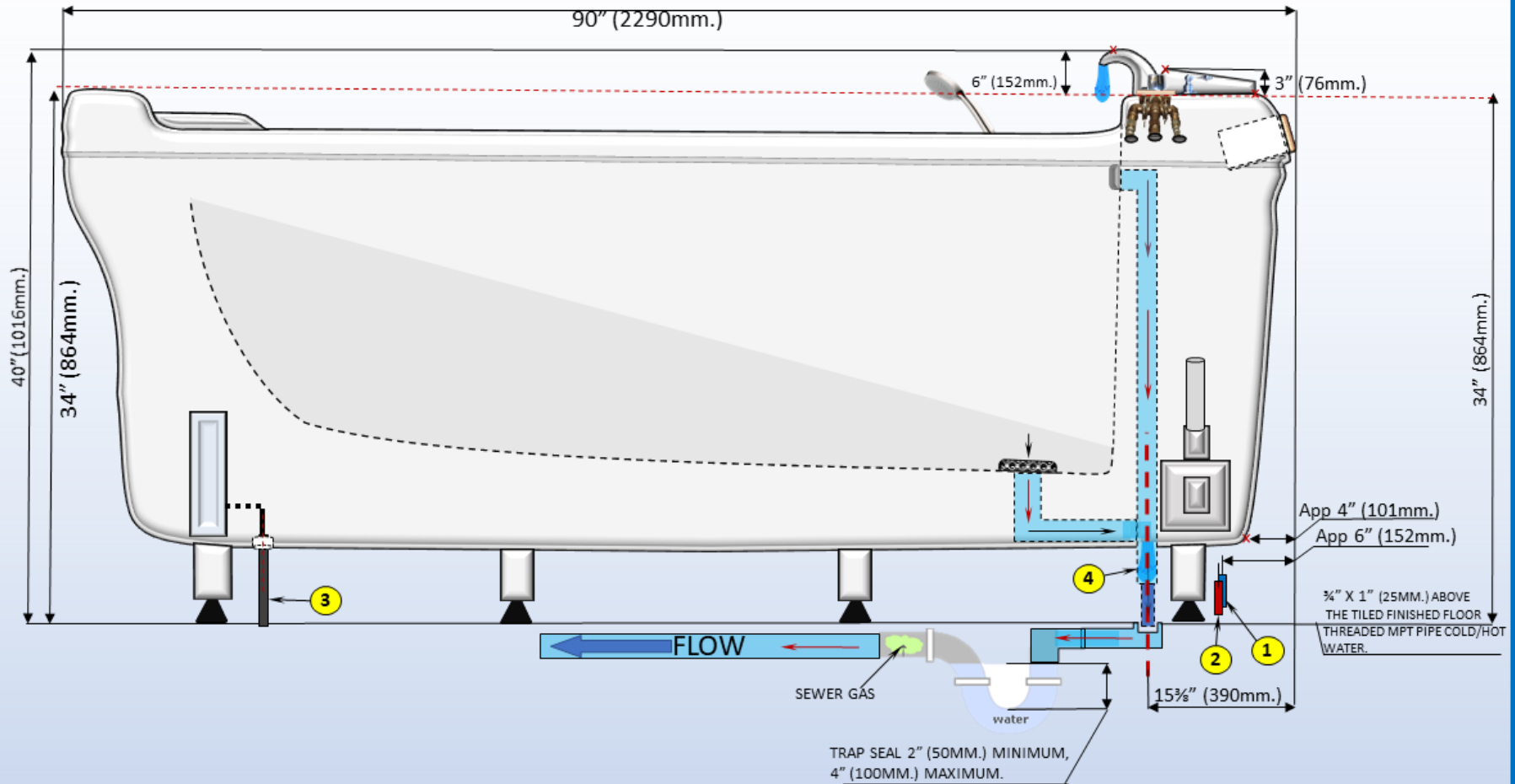

TUB DIAGRAM DESCRIPTION. JUMBO LINE INTELLI-TUB®.

#	FEATURE/PART DESCRIPTION	QTY	NOTES
1	¾" X 1" MPT (25MM.) ABOVE THE FINISHED FLOOR COLD WATER SUPPLY PIPE	1	
2	¾" X 1" MPT (25MM.) ABOVE THE FINISHED FLOOR HOT WATER SUPPLY PIPE	1	
3	3 WIRE ELECTRICAL SUPPLY CABLE 10 GAUGE X 3' (APP.900MM.)	1	TWO IF EQUIPPED WITH ADDITIONAL BOOSTER PUMP FOR UWM KIT (OPTIONAL)SEE INSTRUCTIONS FOR MORE DETAILS.
4	1½" TUB MAIN DRAIN TO FLOOR DRAIN TELESCOPIC CONNECTION.	1	PROFESSIONAL AIR GAP INSTALLATION RECOMMENDED

JUMBO LINE SERIES. INTELLI-TUB® WITH OPTIONAL TWO-SEGMENT HYDROTOP® SYSTEM. INSTALLS IN SECONDS.

TWO-SEGMENT HYDROTOP® ACRYLIC SPA SYSTEM.
CONSISTS OF TWO LIGHTWEIGHT EASY TO INSTALL SEGMENTS WITH
INTEGRATED DRAIN, ANATOMICALLY SHAPED PAD (MATTRESS),
ANATOMICALLY SHAPED HEAD SUPPORT (PILLOW.)

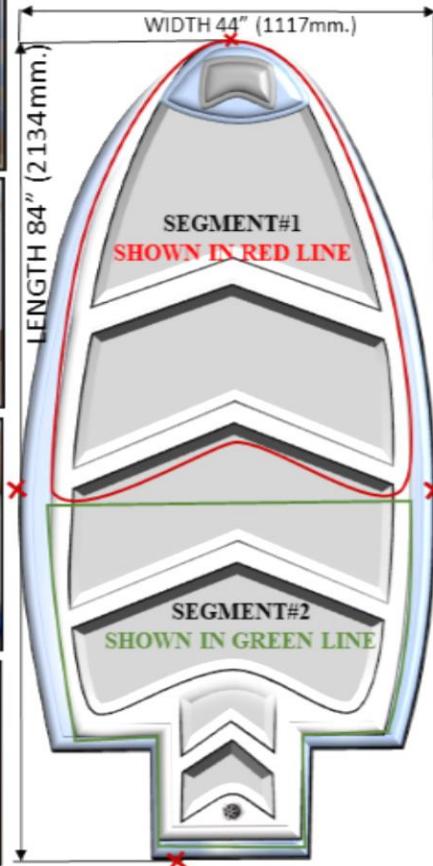

**FOR PROFESSIONAL HYDROTHERAPY TUBS JUMBO LINE (ALL MODELS),
TR-320MB-JL, L-105 JUMBO DE-LUXE. *INSTALLS IN SECONDS.***

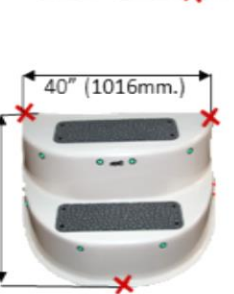
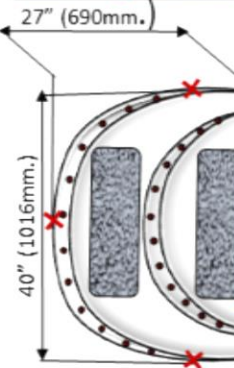

DOUBLE STEP:
W 40" X DEPTH 27" X H 16"

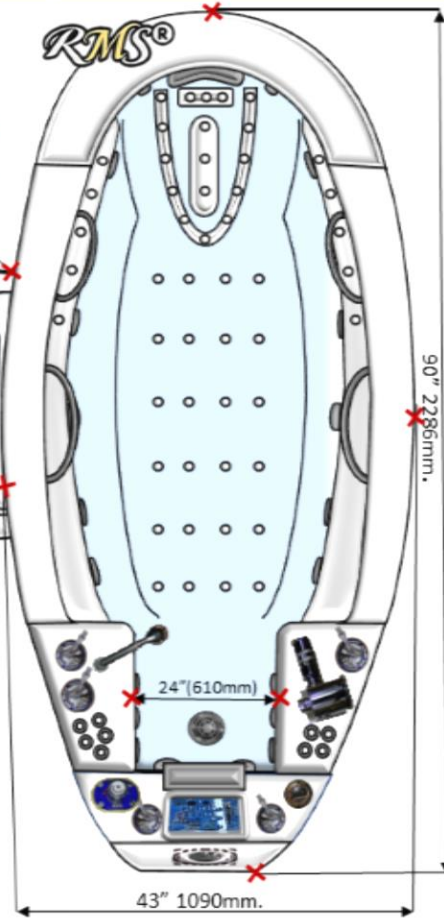

RMS® TUB WITH TWO SEGMENT HYDROTOP® INSTALLED. TUB SHOWN WITH TWO STEPS FOR X-TRA CONVENIENCE.

TWO SEGMENT HYDROTOP® FOR MODELS:

1. JUMBO LINE,
2. TR-320MB-JL
3. L-105 JUMBO DE-LUXE

JUMBO LINE C-280 MA TUB WITH HYDROTOP®. SHOWN WITH TWO DOUBLE STEPS FOR X-TRA CONVENIENCE. HYDROTOP® AND STEPS FIT ALL JUMBO LINE MODELS, TR-320MB-JL, L-105 JUMBO DE-LUXE.

TWO SEGMENT HYDROTOP® FOR MODELS:

1. JUMBO LINE,
2. TR-320MB-JL
3. L-105 JUMBO DE-LUXE

RMS® JUMBO LINE C-280 MA-08 SEA BREEZE TUB WITHOUT HYDROTOP®.

TWO SEGMENT HYDROTOP® FOR MODELS:

1. JUMBO LINE
2. TR-320MB-JL
3. L-105 JUMBO DE-LUXE

97 3/8" (2473 mm.)

27" (686 mm.)

102" (2591 mm.)

84" (2134 mm.)



JUMBO LINE INTELLI-TUB®

WITH OPTIONAL TWO SEGMENT HYDROTOP® SYSTEM AND VICHY SHOWER VO-7 SW-OT EXCLUSIVE.

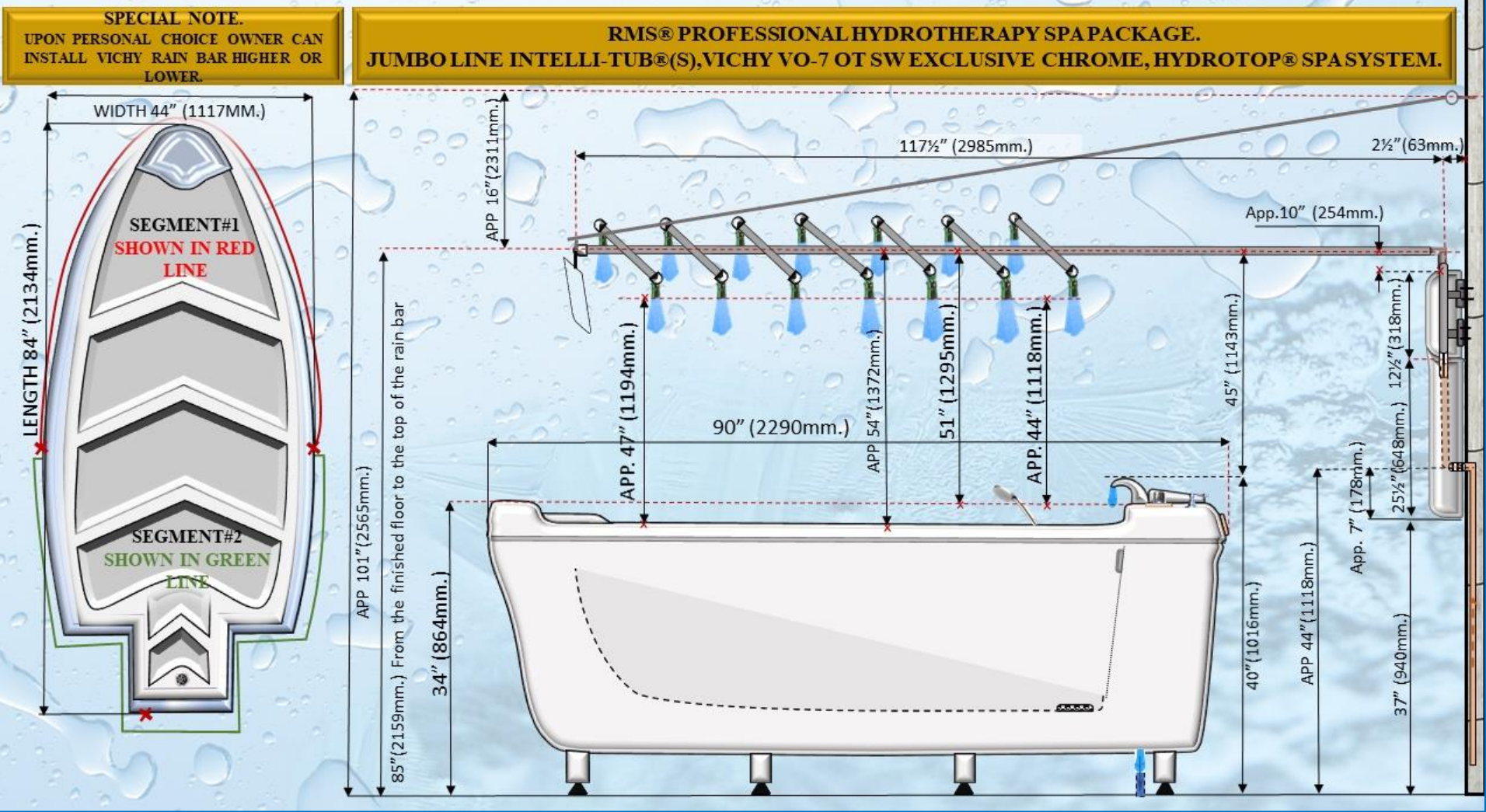

PROFESSIONAL HYDROTHERAPY INTELLI-TUB® JUMBO LINE.
HYDROTOP® ACRYLIC SPA SYSTEM. CONSISTS OF TWO LIGHT WEIGHT, EASY TO INSTALL SEGMENTS WITH INTEGRATED DRAIN, ANATOMICALLY SHAPED PAD (MATTRESS), ANATOMICALLY SHAPED HEAD SUPPORT (PILLOW.)
VICHY V-07 SW EXCLUSIVE-OT CHROME.

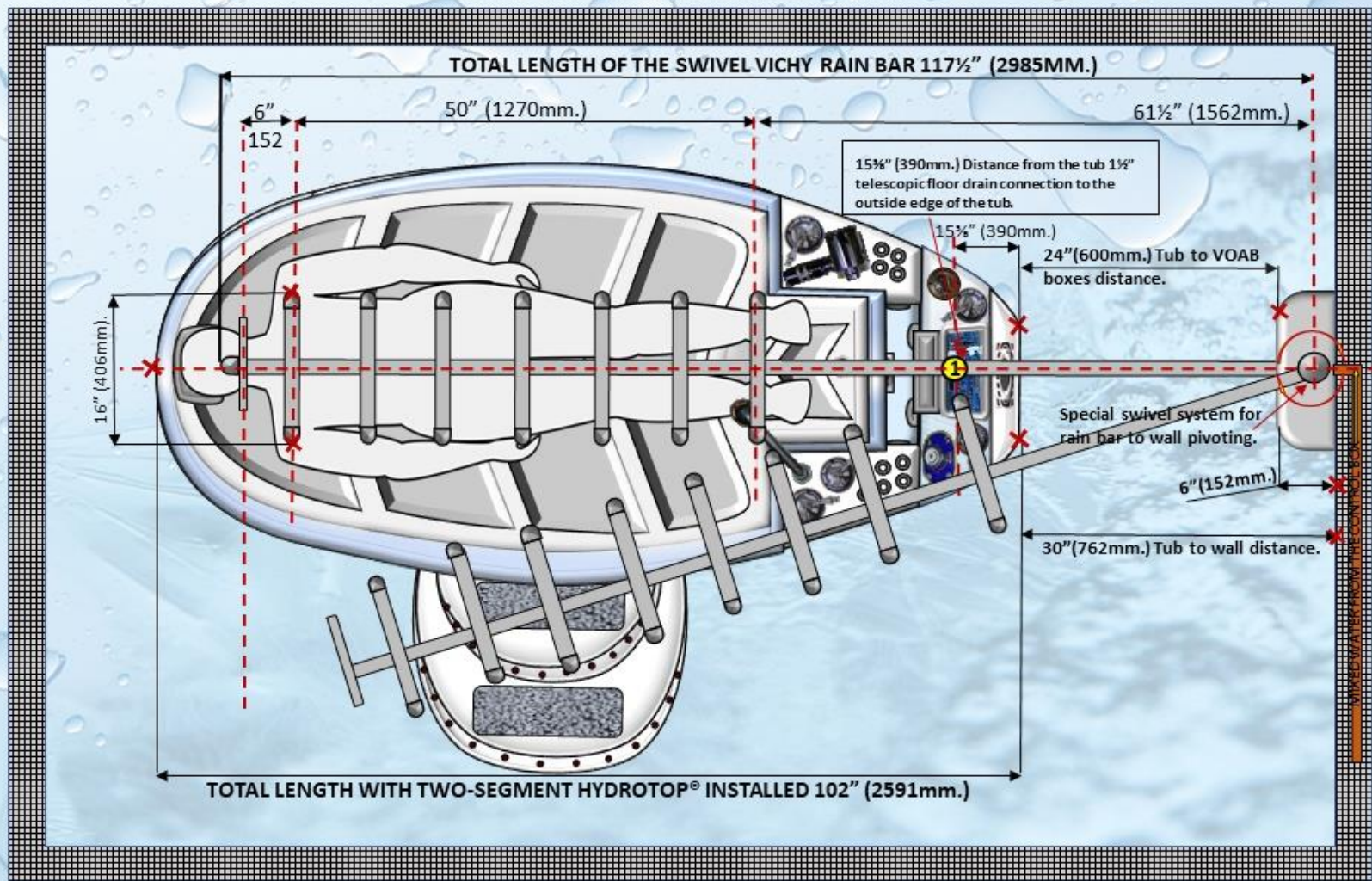

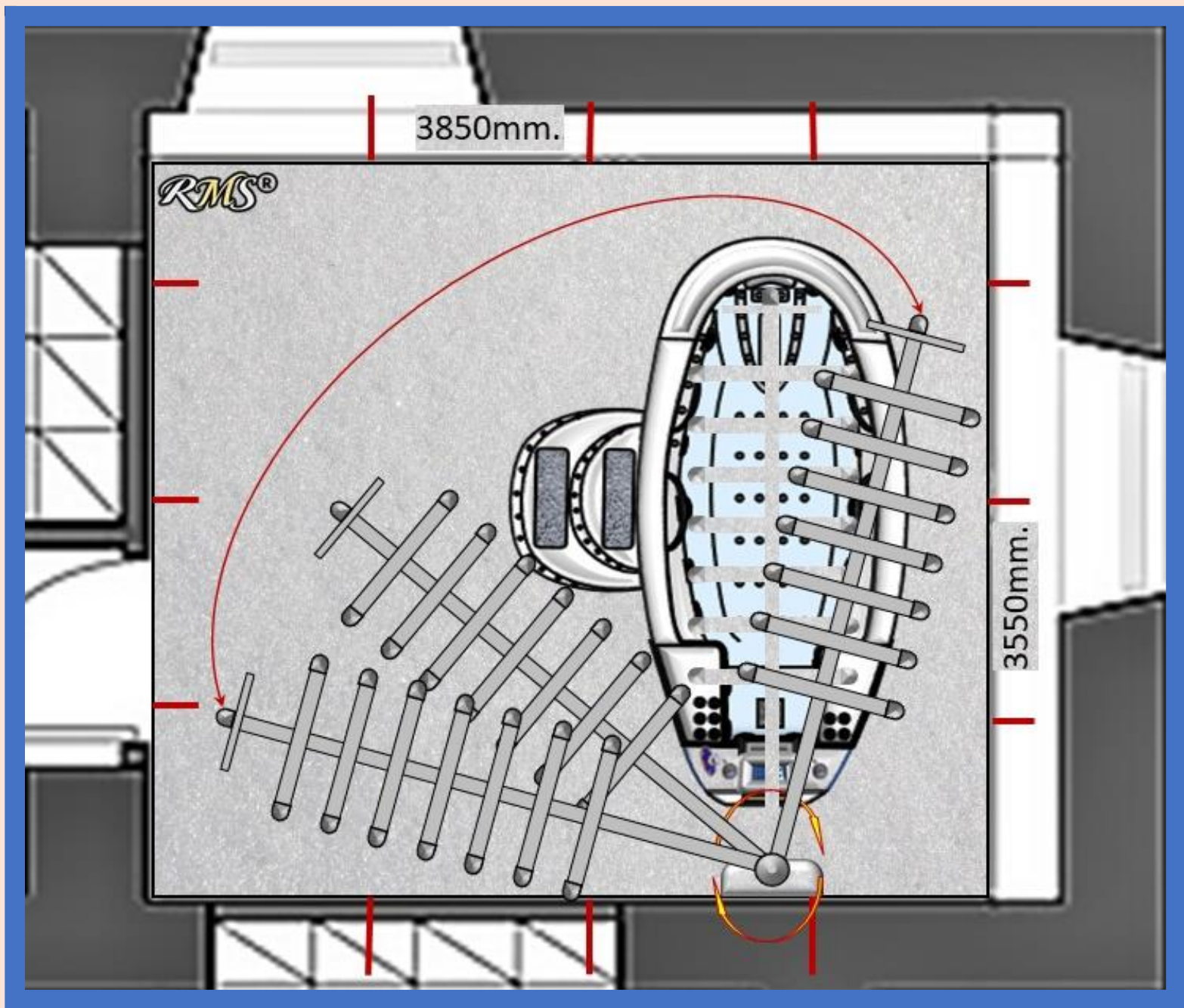

JUMBO LINE SERIES. INTELLI-TUB®

WITH OPTIONAL HYDROTOP® SYSTEM AND VICHY SHOWER VO-7 SW-OT EXCLUSIVE.

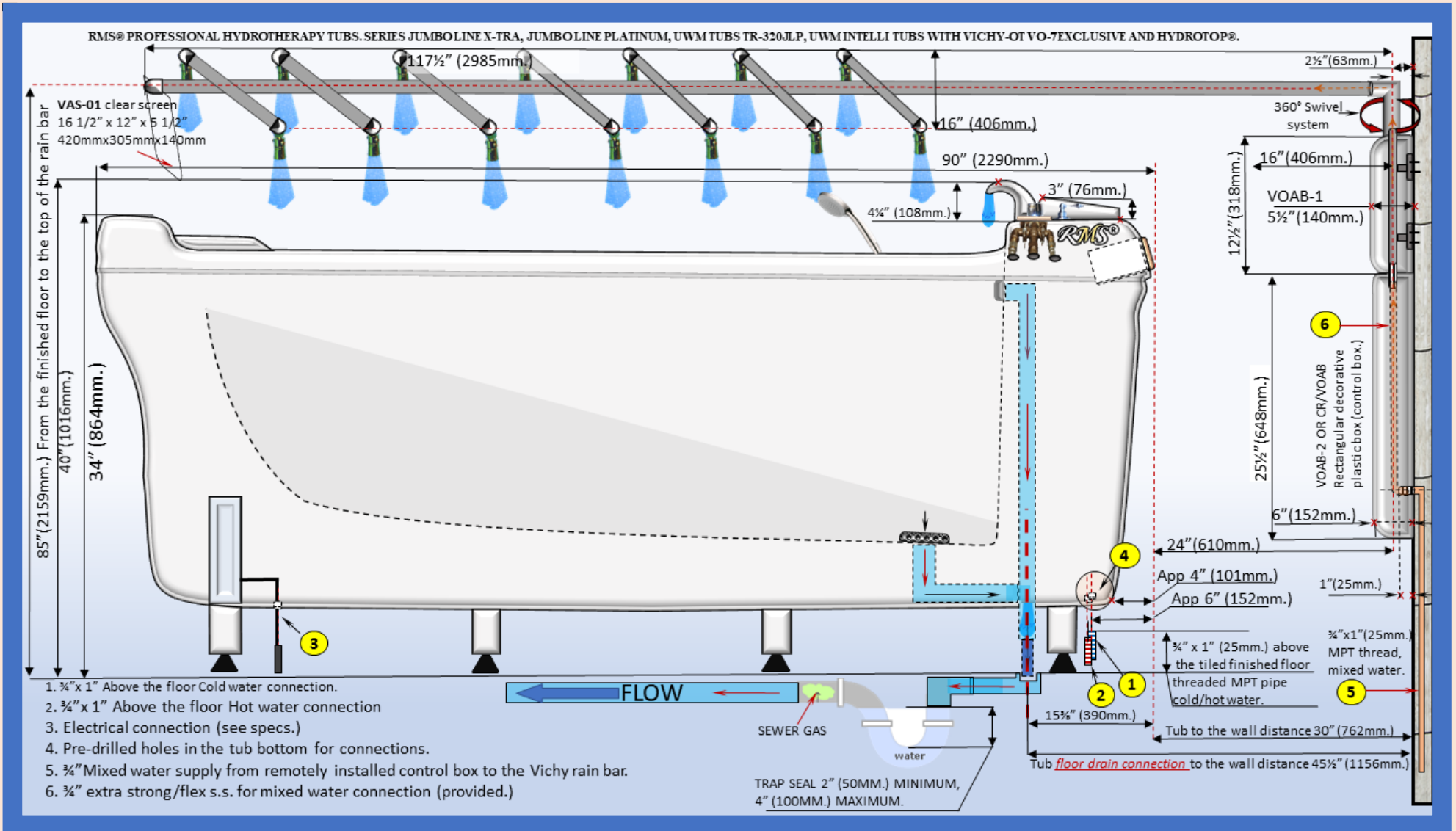

#1

**PROFESSIONAL HYDROTHERAPY SPA PACKAGE FOR COMMERCIAL AND RESIDENTIAL SPA CENTERS.
JUMBO LINE SERIES. INTELLI-TUB® WITH OPTIONAL HYDROTOP® SYSTEM, VICHY SHOWER
VO-7 SW-OT EXCLUSIVE, CHARCOT SHOWER SYSTEM, INTEGRATED INTO UNIVERSAL WALL-MOUNT
CONTROL BOX CR-200A.**

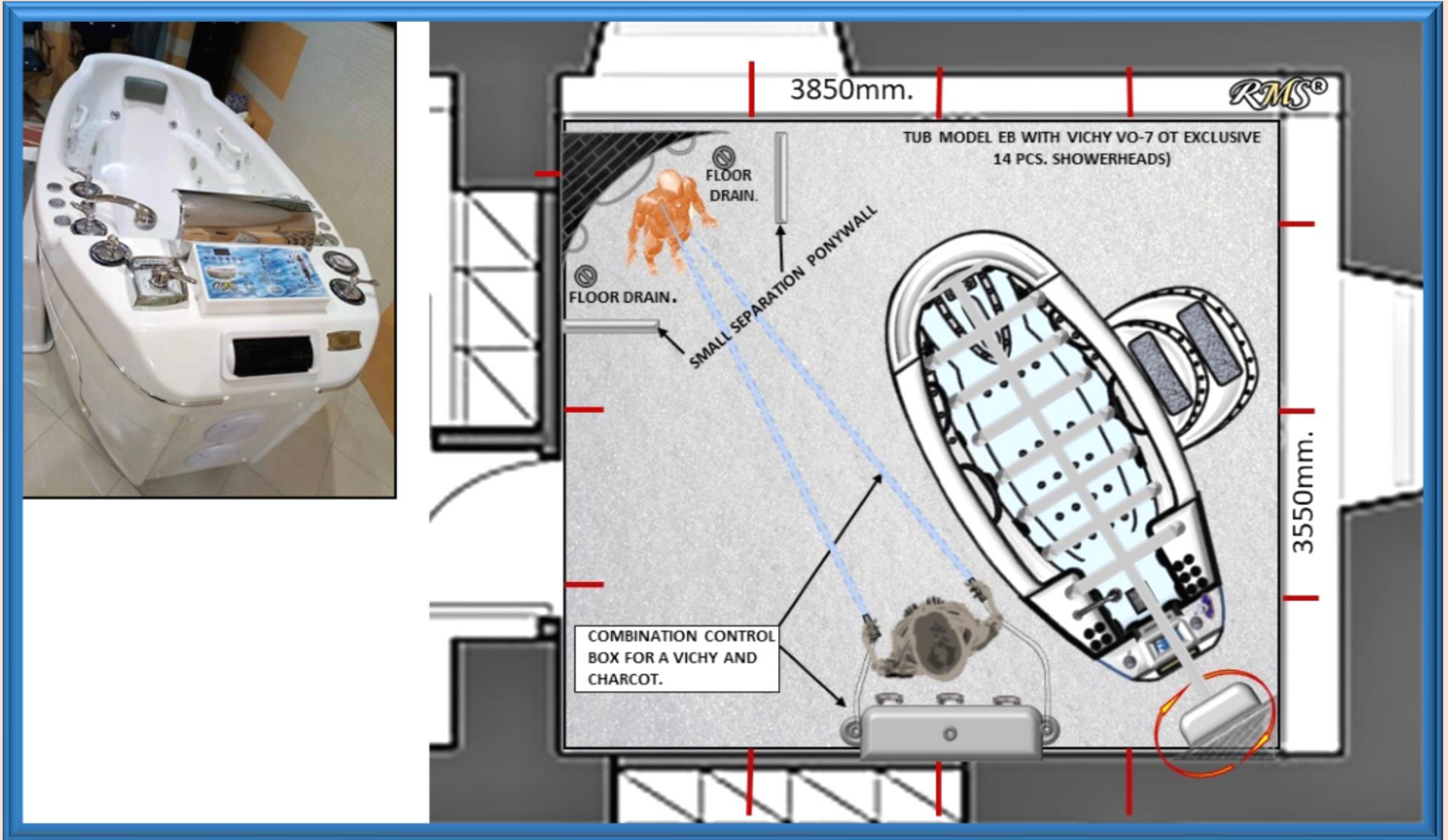

EXAMPLE OF A PROFESSIONAL SPA ROOM DESIGN.

1. MIN. 2" (50MM.) TUB MAIN FLOOR DRAIN FOR AIR GAP MEANS PROFESSIONAL CONNECTION.
2. MIN. 2" (50MM.) TUB/SHOWER SIDE FLOOR DRAIN. CONNECTS TO THE TUB MAIN FLOOR DRAIN BY MEANS OF CROSS, TEE OR ELBOW. COLLECTS AND DRAINS SPILLED OR SPLASHED WATER. CONVENIENT FOR QUICK FLOOR CLEANING AROUND THE TUB BETWEEN TREATMENTS.
3. 2" (50MM.)-2PCS. FLOOR DRAINS FOR CHARCOT SHOWER AND CASCADE SHOWER TREATMENT AREA. DRAINS CONNECT TO THE TUB MAIN FLOOR DRAIN BY MEANS OF TEE OR ELBOW. COLLECT AND DRAINS SPILLED OR SPLASHED WATER. CONVENIENT FOR QUICK FLOOR CLEANING AROUND THE TUB BETWEEN TREATMENTS.
4. CR-200A CHARCOT MAIN CONTROL BOX WITH AUTOMATIC TEMPCONTROL FOR VICHY VO-7 OT EXCLUSIVE AND CASCADE SHOWERS. EQUIPPED WITH INTEGRATED CHARCOT SHOWER SYSTEM.
5. CASCADE SHOWER. MIXED WATER SUPPLIED FROM THE MAIN CONTROL BOX. (DIFFERENT MODELS AVAILABLE.)
6. VOAB1, VOAB-2 STACKED WALL- MOUNT DECO BOXES.

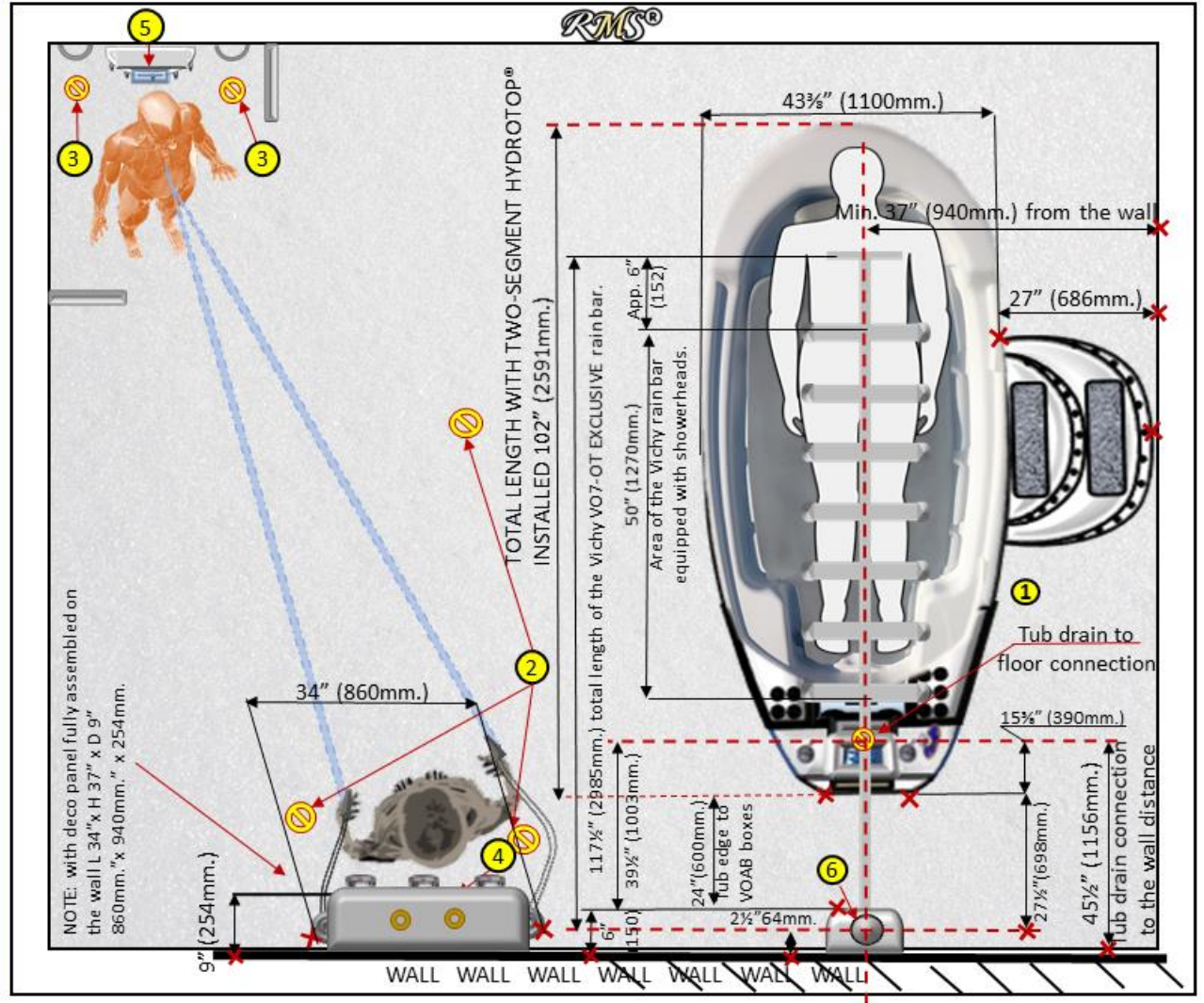

EXAMPLE OF A PROFESSIONAL SPA ROOM DESIGN.

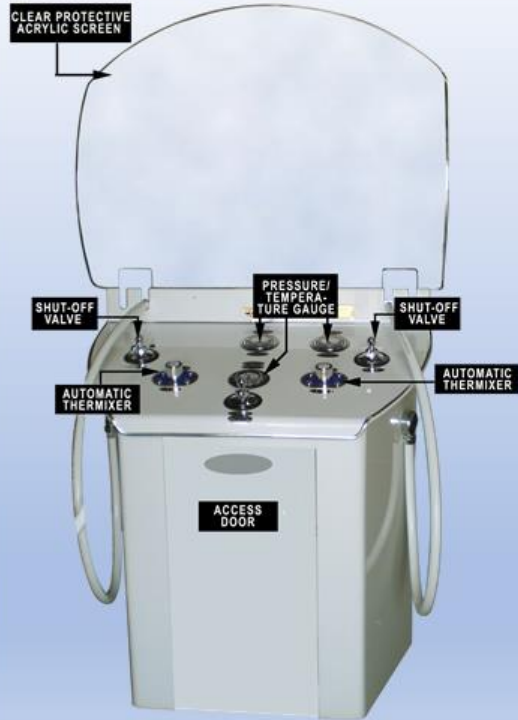

DIFFERENT MODELS AVAILABLE

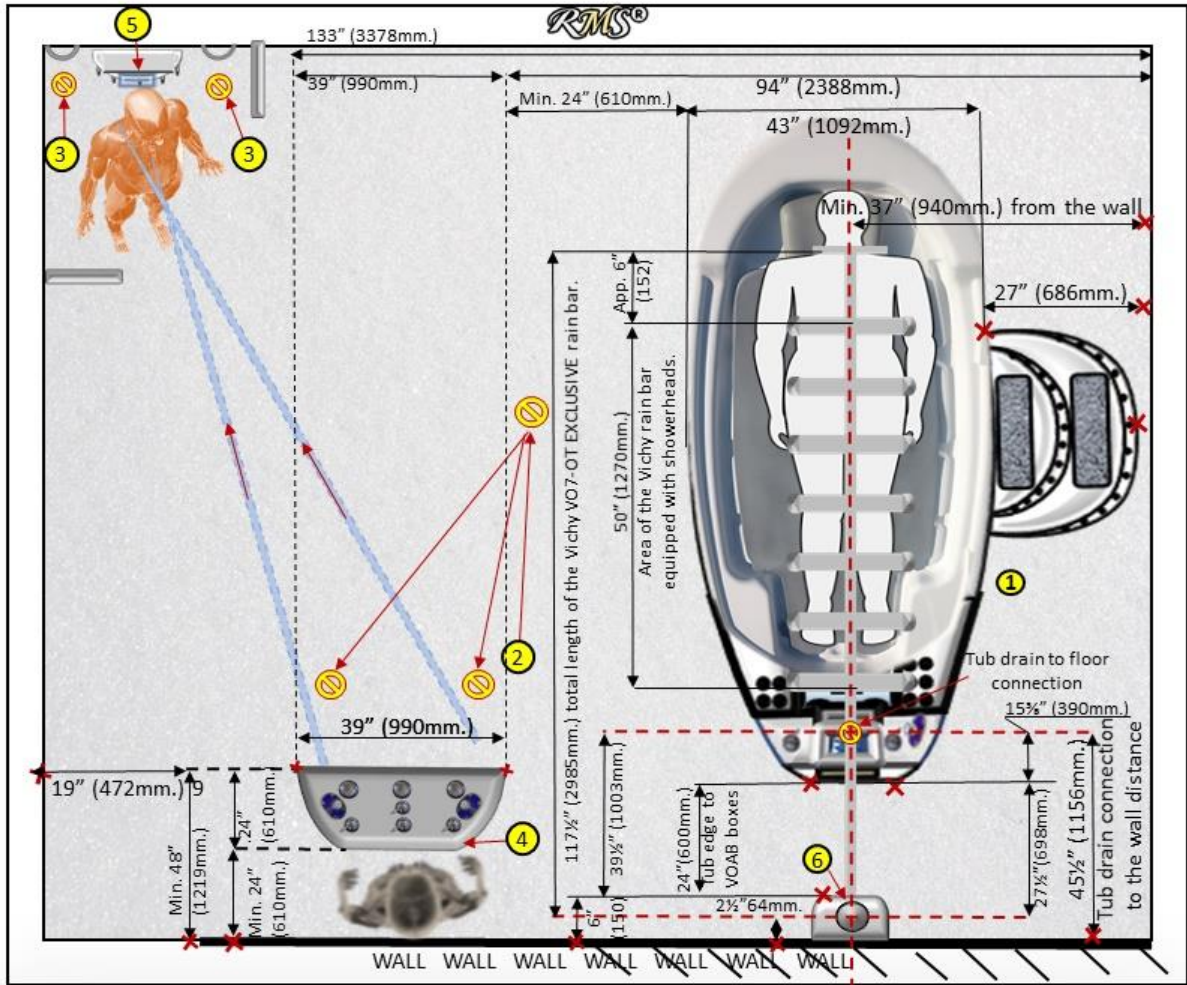

#1

**PROFESSIONAL HYDROTHERAPY SPA PACKAGE FOR COMMERCIAL AND RESIDENTIAL SPA CENTERS.
JUMBO LINE SERIES. INTELLI-TUB® WITH OPTIONAL HYDROTOP® SYSTEM, VICHY SHOWER
VO-7 SW-OT EXCLUSIVE, CHARCOT SHOWER SYSTEM, INTEGRATED INTO UNIVERSAL WALL-MOUNT
CONTROL BOX CR-200A.**

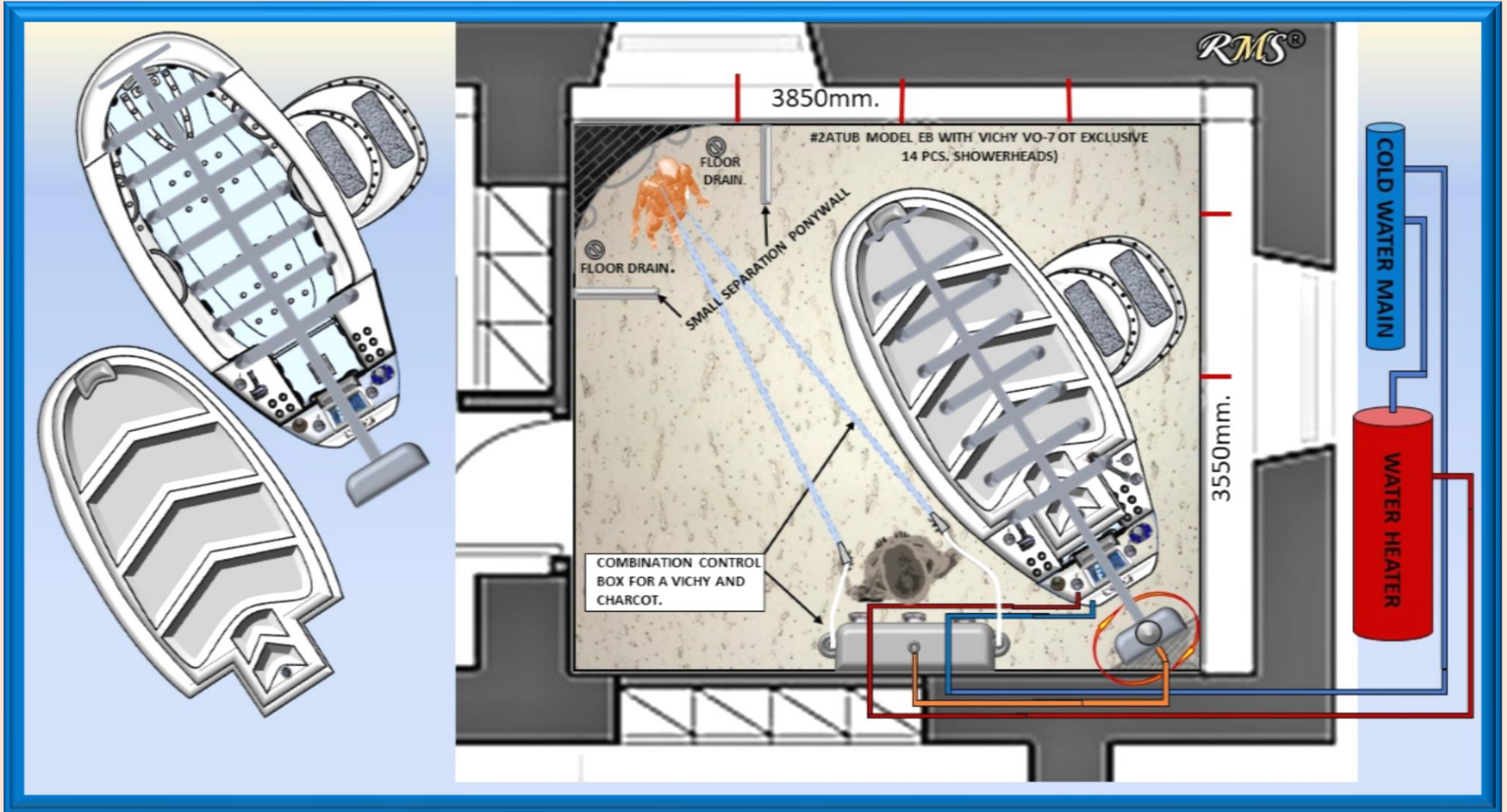

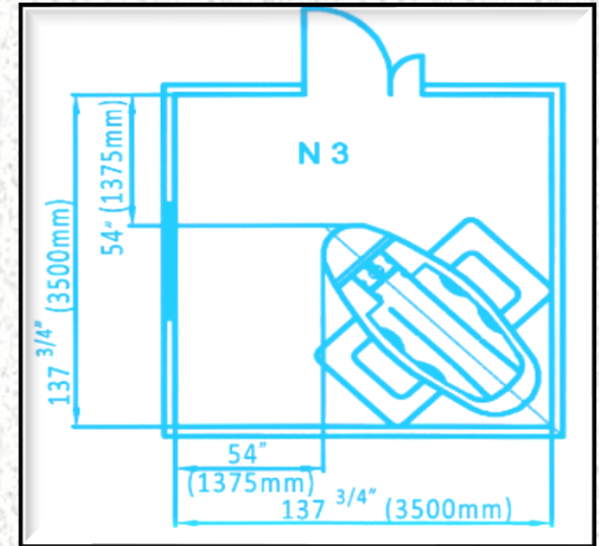
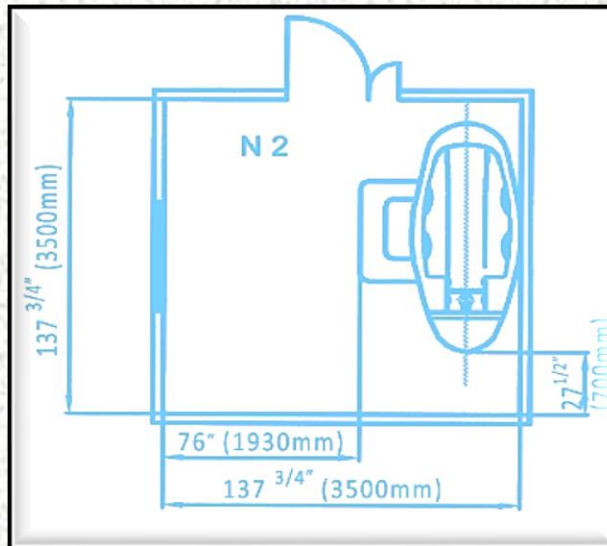
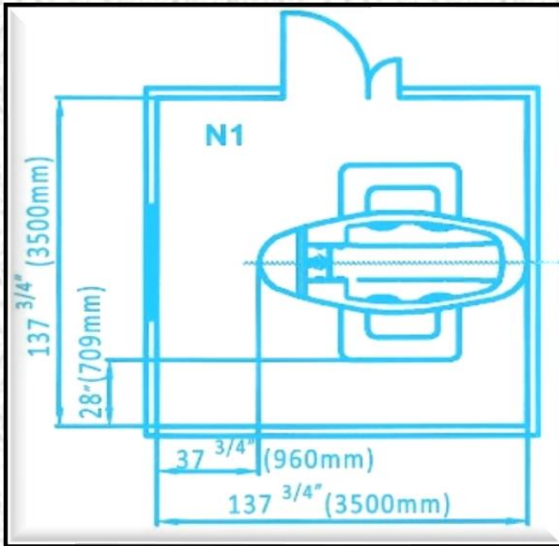

CHAPTER 3 (3.1-3.2) SPECIFICATIONS. JUMBO LINE SPA INTELLI TUB®(S)

CHAPTER 3.1. SPECIFICATIONS. JUMBO LINE SPA INTELLI TUB®(S) JUMBO LINE SUPER-PREMIUM SERIES. INTELLI-TUB®. OVERSIZED EXTRA LUXURY HYDROTHERAPY TUBS



UNIQUE OCEAN YACHT BODY



**HYDRO THERAPY TUBS FOR
COMMERCIAL AND RESIDENTIAL USE.**

FEATURES		C-280 T MA-08 <i>CRYSTAL COVE LE</i> INTELLI-TUB®	C-280 T MA-08 <i>CRYSTAL COVE</i> INTELLI-TUB®	C-280 T MA-08 <i>SEA BREEZE</i> INTELLI-TUB®
TUB DIMS		90" (L) X 43" (W) X 45" (H) 229CM (L)X109CM (W) X 116CM (H)	90" (L) X 43" (W) X 38" (H) 229CM (L)X109CM (W) X 97CM (H)	90" (L) X 43" (W) X 38" (H) 229CM (L)X109CM (W) X 97CM (H)
DIMS CRATED	TUB (crate)	96" (L) X 49" (W) X 50" (H) 244CM (L) X 124CM (W)X127CM (H)	96" (L) X 49" (W) X 44 ½" (H) 244CM (L) X 124CM (W)X113CM (H)	96" L X 49" (W) X 44 ½" (H) 244CM X 124CM X 113CM
	SAFETY LADDER (box)	42" (L) X 29" (W) X 26" (H) 107CM (L) X 74CM (W) X 66CM (H)	39 ½" (L) X 20" (W) X 10" (H) 100CM (L) X 51CM (W) X 25 CM (H)	39 ½" (L) X 20" (W) X 10" (H) 100CM (L) X 51CM (W) X 25 CM (H)
CAPACITY		128 GALLON/488L		
SAFETY LADDER EQUIPPED WITH SOFT PEBBLE TYPE MAT		MODEL DSTL-M24 2 STEP SAFETY LADDER. EQUIPPED WITH 24 EXTRA-BRIGHT MINI-LIGHTS (3 LED EACH, 72 LED TOTAL)	MODEL SSL-01L 1 STEP SAFETY LADDER EQUIPPED WITH SO 11 EXTRA-BRIGHT MINI- LIGHTS (3 LED EACH), 33 LED TOTAL	SSL-01S 1 STEP SAFETY LADDER NO MINI-LIGHTS
ADJUSTABLE FEET WITH ANTI VIBRATION SYSTEM		7PCS	7PCS	7PCS
WATER PUMP 220V/60HZ OR 220V/50HZ		3 HP W/DRY RUN PUMP PROTECTION.	3 HP W/DRY RUN PUMP PROTECTION.	3 HP W/DRY RUN PUMP PROTECTION.
BLOWER / AIR PUMP 220V/60HZ OR 220V/50HZ		2 HP, 16 INTENSITY LEVELS, HEATED AIR	1.5 HP, 16 INTENSITY LEVELS, HEATED AIR	1.5 HP, 16 INTENSITY LEVELS, HEATED AIR
FILL SPOUT		SPECIAL 14" SOLID BRASS CHROME PLATED WATERFALL	SPECIAL 15" SOLID BRASS CHROME PLATED WATERFALL	SPECIAL 15" SOLID BRASS CHROME PLATED WATERFALL
Fairing/Low Skirt Special skirt design features elegant fairing with chrome moldings. Fairing is wrapping around the bottom of the tub and the floor to cover plumbing, etc. Creates a high-end designer's looks to the tub.		+	OPTION	OPTION
ENTERTAINMENT CENTER ARCH TOP SIDE INTELLI TUB® CONTROL SYSTEM		+	-	-
"FOG"/TROPICAL MIST SYSTEM		EC-3ZL R.3/SAS TS ADVANCED ELECTRONIC INTELLI TUB® CONTROL SYSTEM WITH 2 DISPLAYS AND PERIMETER MINI-LIGHTS.		-
		+ "TROPICAL MIST"- INNOVATIVE INVIGORATING FOG SYSTEM WITH ADJUSTABLE FOG TEMP.		-

**JUMBO LINE SUPER-PREMIUM SERIES:
INTELLI-TUB®.
OVERSIZED EXTRA LUXURY HYDROTHERAPY TUBS**



UNIQUE OCEAN YACHT BODY



**HYDRO THERAPY TUBS FOR
COMMERCIAL AND RESIDENTIAL USE.**

CHAPTER 3.1. SPECIFICATIONS. JUMBO LINE SPA INTELLI TUB®(S)

FEATURES		C-280 T MA-08 <i>CRYSTAL COVE LIMITED EDITION</i> INTELLI-TUB®	C-280 T MA-08 <i>CRYSTAL COVE</i> INTELLI-TUB®	C-280 T MA-08 <i>SEA BREEZE</i> INTELLI-TUB®
ELECTRONIC TOP SIDE CONTROL	AUTOMATIC FILL	+	+	+
	AUTOMATIC DRAIN	+	+SEMI AUTOMATIC INTELLI DRAIN WITH PLUMBING SYSTEM AND WATER SANITATION CYCLE. WITH DOUBLE POP-UP DRAIN	
	FULLY AUTOMATIC INTELLI TUB® OZONE SANITATION/ THERAPY SYSTEM	+ OZONATOR FOR BATH WATER AND PLUMBING SANITATION SYSTEM.THIS TUB IS EQUIPPED WITH OZONE GENERATOR THAT AUTOMATICALLY BEGINS INFUSING OZONE INTO THE BATH WATER WHEN THE INTELLI TUB® SANITATION PROGRAM ACTIVATES IT IN ORDER TO IMPROVE THE SANITARY QUALITY OF THE WATER WHILE BATHING. OZONE'S ROLE IS TO REACT WITH NON-LIVING BATHER WASTE ONLY. DISINFECTION IS CARRIED OUT BY CHLORINE CONTAINED IN CLEAN CITY WATER THAT FILLS THE TUB EVERY TIME FOR EACH TREATMENT. OZONE INCREASES CHLORINE'S EFFECTIVENESS AS A BIOCIDES AND RESIDUAL. THE DISINFECTION IS ACHIEVED BY MAINTAINING FREE AVAILABLE CHLORINE IN THE WATER AT EACH TREATMENT.		
	LARGE UNDERWATER LIGHTS	6 UNDERWATER LIGHTS (24 LED EACH), 144PCS. LED TOTAL. ELECTRONIC CONTROL.	6 UNDERWATER LIGHTS (9 LED EACH). 54PCS. LED TOTAL. ELECTRONIC CONTROL	6 UNDERWATER LIGHTS (9 LED EACH). 54PCS. LED TOTAL. ELECTRONIC CONTROL.
	EXTRA-BRIGHT PERIMETER MINI- LIGHTS	31 LIGHTS AROUND WATERFALLS, 6 LIGHTS INTEGRATED INTO ENTERTAINMENT ARCH + 24 MINI-LIGHTS IN SAFETY LADDER	16 MINI-LIGHTS PLACED AROUND WATERFALLS + 11 MINI-LIGHTS IN SAFETY LADDER	OPTION
	STEP LADDER EXTRA-BRIGHT CONTOUR MINI-LIGHTS SYNCHRONIZED WITH THE TUB UNDERWATER AND MINI-LIGHT SYSTEM.	EQUIPPED WITH 24 EXTRA-BRIGHT MINI- LIGHTS (3 LED EACH, 72 LED TOTAL)	EQUIPPED WITH SO 11 EXTRA-BRIGHT MINI- LIGHTS (3 LED EACH), 33 LED TOTAL	NO MINI-LIGHTS
	TOP SIDE ELECTRONIC CONTROL PERIMETER ACCENT EXTRA BRIGHT LED(S) WITH CONTROL BUTTONS	28PC. (3LED EACH). 84PC.TOTAL.		
	TOP SIDE ELECTRONIC CONTROL BUTTONS LED(S)	49PCS.		
TOTAL LED	386PCS. LED	214PCS. LED	187PCS. LED	

**JUMBO LINE SUPER-PREMIUM SERIES.
INTELLI-TUB®.
OVERSIZED EXTRA LUXURY HYDROTHERAPY TUBS**



UNIQUE OCEAN YACHT BODY



**HYDRO THERAPY TUBS FOR
COMMERCIAL AND RESIDENTIAL USE.**

CHAPTER 3.1. SPECIFICATIONS. JUMBO LINE SPA INTELLI TUB®(S)

FEATURES		C-280 T MA-08 <i>CRYSTAL COVE LIMITED EDITION</i> INTELLI-TUB®	C-280 T MA-08 <i>CRYSTAL COVE</i> INTELLI-TUB®	C-280 T MA-08 <i>SEA BREEZE</i> INTELLI-TUB®
ELECTRONIC TOP SIDE CONTROL	MANUAL BODY MASSAGE	+	+	+
	PROGRAM 1	+	+	+
	PROGRAM 2	+	+	+
	PROGRAM 3	+	+	+
	PROGRAM 4	+	+	+
	PROGRAM 5 (SELF-PROGRAMMED MODE)	+	+	+
	START PRE-PROGRAM-MED MODES	+	+	+
	MAIN WATERFALL W. IND. CONTROL VALVE	+	+	+
	LATERAL WATERFALLS WITH INDIVIDUAL CONTROL VALVES. TARGETED LATERAL, ABDOMINAL, CHEST AND BELLY MASSAGE SYSTEM.	+ ELECTRONIC CONTROL	+ ELECTRONIC CONTROL	+ ELECTRONIC CONTROL
	THERAPY ZONES	3+1	3 +1	3 +1
	TOTAL BODY MASSAGE	+	+	+
	AIR MASSAGE ON/OFF WITH HEATED AIR	+	+	+
	INTEGRATED AROMATHERAPY SYSTEM	+	+	+
	TEMPERATURE MONITOR	+	+	+
TIME MONITOR	+	+	+	
AUTOMATIC WATER MIXING AND TEMPERATURE CONTROL SYSTEM.	+	+	+	

**JUMBO LINE SUPER-PREMIUM SERIES.
INTELLI-TUB®.
OVERSIZED EXTRA LUXURY HYDROTHERAPY TUBS**



UNIQUE OCEAN YACHT BODY



**HYDRO THERAPY TUBS FOR
COMMERCIAL AND RESIDENTIAL USE.**

CHAPTER 3.1. SPECIFICATIONS. JUMBO LINE SPA INTELLI TUB®(S)

FEATURES		C-280 T MA-08 <i>CRYSTAL COVE LIMITED EDITION</i> INTELLI-TUB®	C-280 T MA-08 <i>CRYSTAL COVE</i> INTELLI-TUB®	C-280 T MA-08 <i>SEA BREEZE</i> INTELLI-TUB®
MARINE GRADE ENTERTAIN MENT	CD PLAYER/AM/FM RADIO	+	+	+
	SPEAKERS (25W EACH)	4	2	2
	WIRELESS REMOTE	+	+	+
	WIRED REMOTE	+	+	Option
HAND SHOWER WITH INDIVIDUAL CONTROL VALVE		+	+	+
BUILT-IN HEAD SUPPORT/PILLOW		+	+	+
HAND WAND FOR UNDERWATER MASSAGE		OPTION	OPTION	OPTION
CARTRIDGES FOR AROMATHERAPY		SET OF 4 PCS	SET OF 4 PCS	SET OF 4 PCS
VENTURI SYSTEM	TOTAL WATER/AIR JETS	18	18	18
	JUMBO JET	8	8	8
	MEDIUM JETS	6	6	6
	SMALL JETS	4	4	4
	OZONE JET	1PC	1 PC	1PC
INDIVIDUAL AIR CONTROLS FOR THERAPY ZONES 1-3		+	+	+
AIR JETS	TOTAL AIR JETS	48JETS X 5= 240 AIR CHANNELS	48JETS X 5= 240 AIR CHANNELS	48JETS X 5= 240 AIR CHANNELS
	LOW BACK, THIGHS, LEGS, FEET	29 JETS X 5 =145 AIR CHANNELS	29 JETS X 5 =145 AIR CHANNELS	29 JETS X 5 =145 AIR CHANNELS
	CERVICAL AND BACK	9 JETS X 5 = 45 AIR CHANNELS	9 JETS X 5 = 45 AIR CHANNELS	9 JETS X 5 = 45 AIR CHANNELS
	ARMS AND HANDS	10 JETS X 5 = 50 AIR CHANNELS.	10 JETS X 5 = 50 AIR CHANNELS.	10 JETS X 5 = 50 AIR CHANNELS.



UNIQUE OCEAN YACHT BODY SHAPE



**CHAPTER 3.2 SPECIFICATIONS.
JUMBO LINE PREMIUM SERIES.
INTELLI-TUB®.
OVERSIZED EXTRA LUXURY
HYDROTHERAPY TUBS**



**HYDRO THERAPY TUBS
FOR COMMERCIAL
AND RESIDENTIAL USE.**



FEATURES		C-280 T MB-08 <i>SEA CORAL</i> INTELLI TUB®	C-280 T MC-08/S <i>SEABAY SPA</i>	C-280 T MC-08/O <i>OCEAN FLOWER</i>
TUB DIMS		90" (L) X 43" (W) X 38" (H) 229CM (L) X 109CM (W) X 97CM (H)	90" (L) X 43" (W) X 38" (H) 229CM (L) X 109CM (W) X 97CM (H)	90" (L) X 43" (W) X 36 ½" (H) 229CM (L) X 109CM (W) X 93CM (H)
DIMS CRATED	TUB (crate)	96" L X 49" (W) X 44 ½" (H) 244CM X 124CM X 113CM	96" L X 49" (W) X 44 ½" (H) 244CM X 124CM X 113CM	96" L X 49" (W) X 44 ½" (H) 244CM X 124CM X 113CM
	SAFETY LADDER (box)	39 ½" (L) X 20" (W) X 10" (H) 100CM (L) X 51CM (W) X 25 CM (H)	39 ½" (L) X 20" (W) X 10" (H) 100CM (L) X 51CM (W) X 25 CM (H)	39 ½" (L) X 20" (W) X 10" (H) 100CM (L) X 51CM (W) X 25 CM (H)
CAPACITY		128 GALLON/488L		
SAFETY LADDER EQUIPPED WITH SOFT PEBBLE TYPE MAT		SSL-01S 1 STEP SAFETY LADDER NO MINI-LIGHTS	OPTION	OPTION
ADJUSTABLE FEET		7PCS	7PCS	7PCS
WATER PUMP 220V/60HZ OR 220V/50HZ		3 HP W/DRY RUN PUMP PROTECTION	3 HP W/DRY RUN PUMP PROTECTION	3 HP W/DRY RUN PUMP PROTECTION
BLOWER/AIR PUMP 220V/60HZ OR 220V/50HZ		1.5 HP, HEATED AIR WITH MULTIPLE INTENSITY LEVELS	1.5 HP, HEATED AIR	1.5 HP, HEATED AIR
FILL SPOUT		SPECIAL 8" SOLID BRASS CHROME PLATED WATERFALL	8" ABS CHROME PLATED WATERFALL	3 ½" SOLID BRASS CHROME PLATED WATERFALL
FAIRING/LOW SKIRT		OPTION	OPTION	OPTION
CONTROLS		EC-3ZL R.3 SAS TS ADVANCED ELECTRONIC CONTROL SYSTEM WITH 2 DISPLAYS.	EC-0ZS R.3TS ADVANCED ELECTRONIC CONTROL SYSTEM WITH DISPLAY.	EC-0ZS R.3 TS ELECTRONIC CONTROL/PNEUMATIC
"FOG" / TROPICAL MIST SYSTEM		OPTION	OPTION	OPTION
FILL		AUTOMATIC WITH AUTOMATIC WATER SANITATION SYSTEM	MANUAL FILL	MANUAL FILL
DRAIN		SEMI - AUTOMATIC/POP-UP DRAIN WITH INTELLI TUB® AUTOMATIC WATER SANITATION SYSTEM.	POP-UP DRAIN	POP-UP DRAIN
UNDERWATER LIGHTS		4PCS.UNDERWATER LIGHTS (9 LED EACH) WITH ELECTRONIC CONTROL. 36PCS. LED TOTAL.	2 UNDERWATER LIGHTS (9 LED EACH) 18PCS. LED TOTAL.	2 UNDERWATER LIGHTS (9 LED EACH) WITH PNEUMATIC CONTROL. 18PCS. LED TOTAL.
TOP SIDE ELECTRONIC CONTROL BUTTONS LED(S)		52PCS.	7PCS.	7PCS.



**CHAPTER 3.2 SPECIFICATIONS.
JUMBO LINE PREMIUM SERIES.
INTELLI-TUB®.
OVERSIZED EXTRA LUXURY
HYDROTHERAPY TUBS**



HYDRO THERAPY TUBS
FOR COMMERCIAL
AND RESIDENTIAL USE.



UNIQUE OCEAN YACHT BODY SHAPE

FEATURES		C-280 T MB-08 <i>SEA CORAL</i> INTELLI TUB®	C-280 T MC-08/S <i>SEABAY SPA</i>	C-280 T MC-08/O <i>OCEAN FLOWER</i>
TOP SIDE ELECTRONIC CONTROL PERIMETER ACCENT EXTRA BRIGHT LED(S) WITH CONTROL BUTTONS		28PC. (3LED EACH). 84PCS.TOTAL.	N/A	N/A
EXTRA-BRIGHT MINI LIGHTS 3 LED EA.		OPTION	OPTION	OPTION
TOTAL LED		54 LED	18 LED	18 LED
MANUAL BODY MASSAGE		+	+	+
THERAPY ZONES		3+1	-	-
LATERAL WATERFALLS W/ IND. CONTROL VALVES		+ WITH ELECTRONIC CONTROL AND 2PCS. CONTROL VALVES	+ WITH 2 CONTROL VALVES	OPTION W/2 CONTROL VALVES
TOTAL BODY MASAGE		+	+	+
AIR MASSAGE ON/OFF HEATED AIR		+	+	+
INTEGRATED AROMATHERAPY SYSTEM		+	+	+
DISPLAY		+ 2 DISPLAYS	+	-
AUTOMATIC WATER MIXING AND TEMP.CONTROL SYSTEM		+	+	MANUAL WATER MIXING SYSTEM
MARINE GRADE ENTERTAINMENT CENTER	CD PLAYER/AM\FM RADIO		OPTION	
	SPEAKERS (25W EACH)		2/OPTION	
	WIRELESS REMOTE		OPTION	
	WIRED REMOTE		OPTION	
DECK- MOUNTED HAND SHOWER WITH INDIVIDUAL CONTROL VALVE		+ UPGRADE TO RETRACTABLE HAND SHOWER AVAILABLE		
BUILT-IN HEAD SUPPORT/PILLOW		+		
HAND WAND FOR UNDERWATER PRESSURE POINTED MASSAGE		OPTION		
CARTRIDGES FOR AROMATHERAPY		SET OF 4 PCS	SET OF 4 PCS	SET OF 4 PCS



UNIQUE OCEAN YACHT BODY SHAPE



**CHAPTER 3.2 SPECIFICATIONS.
JUMBO LINE PREMIUM SERIES.
INTELLI-TUB®.
OVERSIZED EXTRA LUXURY
HYDROTHERAPY TUBS**



**HYDROTHERAPY TUBS
FOR COMMERCIAL
AND RESIDENTIAL USE.**



FEATURES		C-280 T MB-08 <i>SEA CORAL</i> INTELLI TUB®	C-280 T MC-08/S <i>SEABAY SPA</i>	C-280 T MC-08/O <i>OCEAN FLOWER</i>
VENTURI SYSTEM JETS WITH COMBINATION WATER/AIR MASSAGE	TOTAL WATER/AIR JETS	15	11	11
	JUMBO JET	8	6	6
	MEDIUM JETS	2	2	2
	SMALL JETS	4	2	2
	OZONE JET	1	1	1
	OZONE SANITATION/ THERAPY SYSTEM	<p>+ OZONATOR. BATH WATER AND PLUMBING SANITATION SYSTEM. THIS TUB IS EQUIPPED WITH OZONE GENERATOR THAT AUTOMATICALLY BEGINS INFUSING OZONE INTO THE BATH WATER WHEN THE INTELLI TUB® SANITATION PROGRAM ACTIVATES IT IN ORDER TO IMPROVE THE SANITARY QUALITY OF THE WATER WHILE BATHING. OZONE'S ROLE IS TO REACT WITH NON-LIVING BATHER WASTE ONLY. DISINFECTION IS CARRIED OUT BY CHLORINE CONTAINED IN CLEAN CITY WATER THAT FILLS THE TUB EVERY TIME FOR EACH TREATMENT. OZONE INCREASES CHLORINE'S EFFECTIVENESS AS A BIOCIDES AND RESIDUAL. THE DISINFECTION IS ACHIEVED BY MAINTAINING FREE AVAILABLE CHLORINE IN THE WATER AT EACH TREATMENT.</p>		
INDIVIDUAL AIR CONTROLS FOR THERAPY ZONES 1-3		+	+	+
AIR JETS	TOTAL AIR JETS	26 JETS X 5 = 240 AIR CHANNELS.	16 JETS X 5 =80 AIR CHANNELS	-
	LOW BACK, THIGHS, LEGS, FEET	16 JETS X 5 = 80 AIR CHANNELS.	16 JETS X 5 =80 AIR CHANNELS	-
	CERVICAL AND BACK	4 JETS X 5 = 20 AIR CHANNELS.	-	-
	ARMS AND HANDS	6 JETS X 5 = 30 AIR CHANNELS.	-	-
OPTIONS. JUMBO LINE HYDROTHERAPY TUBS.				
FEATURE				NOTES
<p>HYDROTOP EXTRA -COMFORT: NEW ADVANCED 2-SEGMENT MODEL. MOLDED ACRYLIC TOP FOR ENVELOPMENTS, SCRUBS, SEAWEED, MUD, VICHY, ETC. APPLICATIONS. EASILY INSTALLED IN SECONDS. EQUIPPED WITH DRAIN, VINYL PAD/MATRESS AND HEAD SUPPORT / PILLOW.</p>				
<p>SSL-01L SAFETY LADDER (1 STEP). EQUIPPED WITH SOFT PEBBLE TYPE MAT AND 11 EXTRA-BRIGHT MINI-LIGHTS (3 LED EACH); 33 LED TOTAL. MINI-LIGHTS ARE SYNCHRONIZED WITH MAIN CHROMO THERAPY SYSTEM (FOR MODELS C-280 T MA-08, MB, MC-08 ONLY).</p>				
<p>SSL-01S SAFETY LADDER (1 STEP). EQUIPPED WITH SOFT PEBBLE TYPE MAT. <u>NO MINI-LIGHTS</u> (FOR MODELS C-280 T MB-08/MC-08 ONLY).</p>				
<p>OPTIONAL SET OF AROMATHERAPY CARTRIDGES (4PCS)</p>				
<p>INTEGRATED OZONE SYSTEM.</p>				

MARINE GRADE STEREO SYSTEM (MODELS C-280 T MB-08/MC-08 ONLY)

STEREO SYSTEM INCLUDES:

- HIGH POWER CD PLAYER
- AM/FM RADIO
- SPEAKERS 20W EACH (2PCS.)

11 CONTOUR EXTRA-BRIGHT MINI-LIGHTS PLACED INSIDE THE TUB OR UNDER WATERFALLS (FOR MODELS C-280 T MA-08/MB-08/MC-08 ONLY).

FAIRING/LOW SKIRT SPECIAL SKIRT DESIGN FEATURES NEW ELEGANT FAIRING WITH CHROME MOLDING. FAIRING IS WRAPPING AROUND THE TUB TO COVER THE CLEARANCE BETWEEN THE BOTTOM OF THE TUB AND FLOOR TO COVER PLUMBING, ETC. CREATES A HIGH-END DESIGNER'S LOOK TO THE TUB.

CHAPTER 4. OPTIONS. JUMBO LINE HYDROTHERAPY TUBS.

1. INTELLI TUB® ADDITIONAL LEVELS/FUNCTIONS.
2. OPTIONAL ACCESSORIES AND SPA PACKAGES.
3. OPTIONAL UNDERWATER POINTED PRESSURE MASSAGE EQUIPMENT, SYSTEMS AND ACCESSORIES.
WET ROOM SPA PACKAGES. HYDROTOP® AND “OT” OVER-THE-TUB AFFUSION/VICHY SHOWERS.

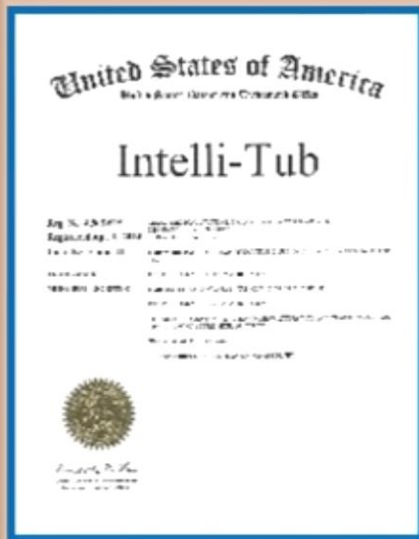

6.1 ABOUT RMS® INTELLI TUB® REGISTERED TRADE MARK.

STANDARD INTELLI TUB® PACKAGE FOR ANY INTELLI®TUB MODEL.

RMS INTELLI-TUB® TRADE NAME TUBS ARE EQUIPPED WITH FULLY AUTOMATIC FILL AND DRAIN SYSTEMS. FILL YOUR TUB WITH WATER OR DRAIN IT WITH JUST A TOUCH OF A BUTTON! ADVANCED VOICE ASSISTANCE SYSTEM IN THE LANGUAGE OF YOUR CHOICE* MAKES TUB OPERATION EASY AND USER-FRIENDLY.

RMS INTELLI-TUB® TRADE NAME TUBS ARE EQUIPPED WITH FULLY AUTOMATIC FILL AND DRAIN SYSTEMS. FILL YOUR TUB WITH WATER OR DRAIN IT WITH JUST A TOUCH OF A BUTTON! ADVANCED VOICE ASSISTANCE SYSTEM IN THE LANGUAGE OF YOUR CHOICE* MAKES TUB OPERATION EASY AND USER-FRIENDLY.

RMS STANDARD INTELLI-PACK.

THIS LEVEL IS PROVIDED WITH THE TUB AS A BASIC INTELLI-PACKAGE THAT CAN BE UPGRADED TO ANY FURTHER LEVEL FROM 2 TO 5 (SEE BELOW).

ENERGY SAVING SYSTEM.

ENVIRONMENTAL FRIENDLY INTERNAL TUB PLUMBING LINES AND WATER SANITATION SYSTEM AND DESIGN.

AUTOMATIC INTELLI-FILL WITH WATER SANITATION.

AUTOMATIC INTELLI-DRAIN SYSTEM WITH WATER SANITATION.

AUTOMATIC INTELLI-POWER FAILURE FILL/DRAIN PROTECTION WITH SPECIAL SANITATION CYCLE.

NOTE: INTELLI-LEVEL 1: INTELLI-PACK IS A STANDARD FEATURE FOR ALL 6- AND 3-ZONE RMS HYDROTHERAPY TUBS MARKED WITH INTELLI-TUB™ AS A PART OF THE MODEL NAME.



4.1 OPTIONS. INTELLI TUB® ADDITIONAL LEVELS/FUNCTIONS.

**LEVEL 1
INTELLI-PACK**

RMS® INTELLI-PACK. STANDARD FOR INTELLI-TUB®

This level is provided with the tub as a basic INTELLI-PACKAGE that can be upgraded to any further level from 2 to 5 (see below).

Energy Saving System.

Environmental Friendly Sanitation System and Design.

Automatic Fill with water sanitation.

Automatic Intelli-Drain system with water sanitation.

Automatic Power Failure Fill/Drain protection and sanitation system.

NOTE: INTELLI-LEVEL 1: INTELLI-PACK is a standard feature for all 6- and 3-zone RMS® hydrotherapy tubs marked with INTELLI-TUB® as a part of the model name.

**LEVEL 2
INTELLI VOICE**

RMS® INTELLI-VOICE. OPTION. ADDS THE FOLLOWING FEATURES TO YOUR TUB:

RMS® TUBS ARE GETTING SMARTER. NOW YOUR TUB CAN TALK TO YOU.

WHICH KINDS OF UNIQUE SERVICES ARE PROVIDED TO THE TUB USERS WITH RMS® INTELLI-VOICE?

RMS® INTELLI-VOICE system provides high-quality verbal support for all tub operations. Speaking in simple words when the user touches the button RMS® INTELLI-VOICE system explains the user which feature has been activated and what's going to happen next.

It is also excellently integrated into your tub electronic user guide/help information.

This feature is significant for the owners of the commercial spa centers. Any time you hire the new tub operator, this system will provide the actual training, needed to operate this tub for all types of hydro-massage treatments. In most cases, one day would be enough to get the person ready to operate the tub

RMS® INTELLI-VOICE System is the excellent help support providing a unique quality of service. Unlike other systems with unpleasant mechanical messages, RMS® INTELLI-VOICE system provides highly pleasant human voices in 5 different languages upon users' choice. RMS® INTELLI-VOICE system is equipped with volume control and high-quality audio system.

RMS® Intelli Tub® talks to you with the dream soft human voices, making your overall bathing experience pleasant and comfortable.

To listen to the actual examples of RMS INTELLI-VOICE system, please visit RMS® website: <http://relaxmedsyst.com/control-panel/>. It is an interactive flash animated page, please, allow a couple of minutes to load.



**LEVEL 3
INTELLI-LINK**

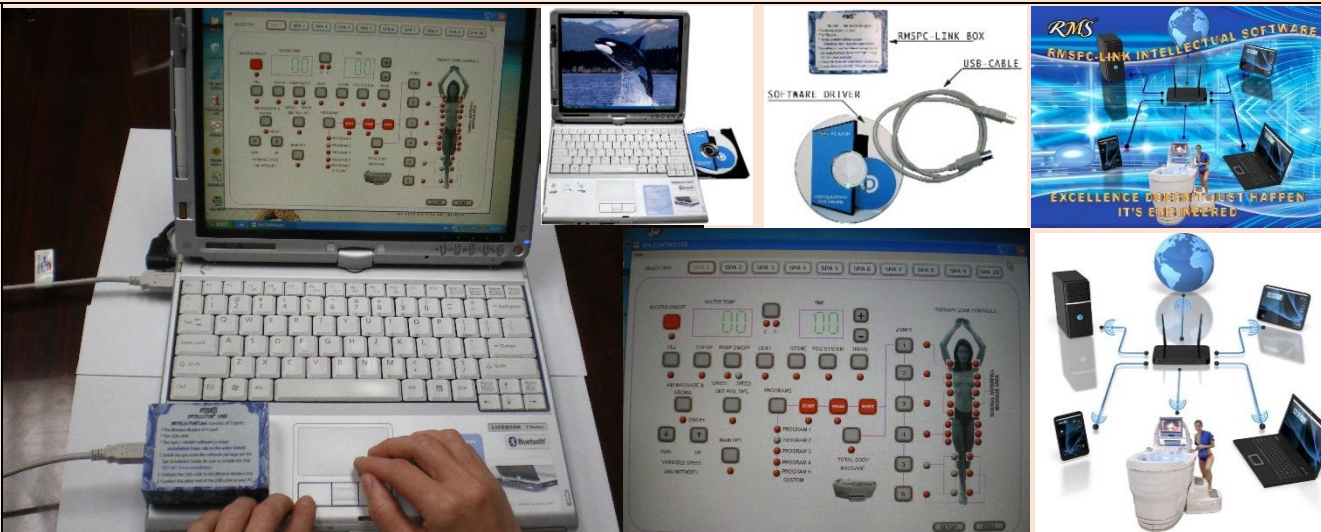

RMS® INTELLI-LINK
Adds the following features:
 Wireless Tub Control through any Windows-based PC (up to 100ft radius).
 Includes RMS® INTELLI-LINK box, driver software, and USB cable.
 Merely connect RMS® INTELLI-LINK box to your PC with USB cable provided. Install RMS® software driver as per instructions provided.
 The actual tub control panel displays on a PC monitor. Mouse-click on any button activates selected feature. NOTE: PC is not included.

**LEVEL 4
INTELLI O-FILL
COMING SOON**

This level could be purchased separately from all other levels or could be combined with any of the RMS® INTELLI-LEVELS 2 through 5. Adds the following features:

INTELLI O-FILL

Intelligent water volume control system will calculate and add or drain the necessary amount of water to/from the tub depending on the bather's body volume.

HOW DOES IT WORK?

The system estimates the body volume of the bather to make a right decision to add water to the tub or to drain water from the tub for maintaining safe and comfortable water level. The system also provides triple overflow protection with the audio signal and immediate water supply shut down that will never let you overflow your tub in your upscale spa resort or luxury home spa.

**LEVEL 5
INTELLI -
DIAGNOSTIC**

CUTTING-EDGE INTELLI-DIAGNOSTIC SYSTEM.

This level could be purchased separately from all other INTELLI-LEVELS 2 through 5 and can work in combination with any of the above INTELLI-LEVELS. Adds the following features:

Provides permanent computerized monitoring of all electrical and electronic features and components performance with feedback.

Visual and audio ERR messages are instantly reporting any problem or service need.

Get yourself a piece of mind, guarantee the easiest and most reliable way of maintaining and servicing your upscale, luxurious bathtub for years to come.

#	OPTIONAL INTELLI FUNCTIONS/SYSTEMS FOR INTELLI-TUB®. DESCRIPTION.	NOTES
1	RMS® INTELLI-VOICE	
2	INTELLI-LINK	
3	INTELLI DIAGNOSTIC	

4.2

OPTIONAL ACCESSORIES FOR JUMBO LINE HYDROTHERAPY TUB WET ROOM SPA PACKAGES. HYDROTOP® AND “OT” OVER-THE-TUB AFFUSION/VICHY SHOWERS.

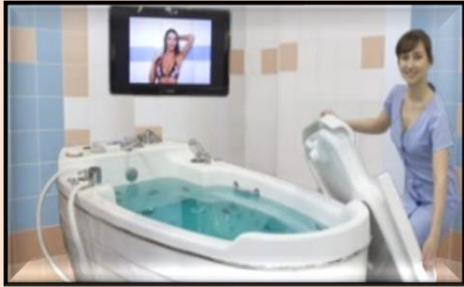

HYDROTOP®: NEW ADVANCED 2-SEGMENT MODEL. MOLDED ACRYLIC TOP FOR ENVELOPMENTS, SCRUBS, SEAWEED, MUD, VICHY, ETC. APPLICATIONS. EASILY INSTALLED IN SECONDS. EQUIPPED WITH DRAIN AND HEAD SUPPORT/PILLOW.



RMS®
TUBS ARE DESIGNED TO BE USED WITH A SPECIAL PROFESSIONAL SYSTEM HYDROTOP® WHICH PROVIDES UNIQUE OPPORTUNITIES FOR ANY SPA. WITHIN LESS THAN 1 MINUTE ANY THERAPIST CAN EASILY INSTALL 2 OR 3-SEGMENT HYDROTOP® ON A TUB, CONVERTING IT INTO A HIGHLY ADVANCED, SELF-DRAINING WETTABLE WITH A SPECIALLY MOLDED HEAD SUPPORT, MATTRESS PAD AND A COMFORTABLE FACE OPENING FOR BACK MASSAGE OR OTHER TYPES OF TREATMENTS REQUIRING THE CLIENT TO LIE DOWN ON THEIR BELLY. IT IS A UNIQUE OPPORTUNITY TO DOUBLE OR TRIPLE THE POTENCY OF THIS TUB. ANY TYPE OF FACIAL, ENVELOPMENTS, PEELINGS, SALT GLOW, OR OTHER TREATMENTS CAN BE ADDED TO YOUR SPA MENU WHEN YOU USE HYDROTOP® AS A PART OF A TUB PACKAGE. A SMALL AMOUNT OF HOT WATER KEEPS HYDROTOP® PERMANENTLY WARM DURING TREATMENT, PROVIDING YOUR CLIENT WITH A COMFORTABLE ENVIRONMENT. FOG SYSTEMS ARE AN EXCELLENT TOOL FOR FACIAL PREPARATION. THIS TREATMENT WILL WRAP YOUR CUSTOMER IN A WARM CLOUD OF MOISTURE RICH AIR, KEEPING THEM COMFORTABLE DURING TREATMENTS. HAND SHOWERS WITH ADJUSTABLE INTENSITIES WILL MAKE RINSING FAST AND EASY. ALL THE BY-PRODUCTS OF TREATMENTS AUTOMATICALLY DRAIN

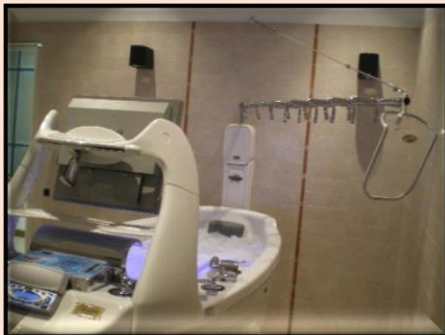

DIRECTLY INTO THE TUB'S MAIN DRAIN. AUTOMATIC TUB SANITATION WILL SAVE YOU TIME, AFTER ALL, ALL YOU NEED TO DO IS PRESS THE DRAIN BUTTON. IN ADDITION TO THE HYDROTOP® SYSTEM, YOU CAN ADD VICHY SHOWERS TO THE SET OF EQUIPMENT COMING WITH THE TUB. RMS® OFFERS THE CHOICE OF THE MOST ADVANCED VICHY SHOWER MODELS, DESIGNED TO FIT OVER THE TUB: VO-7-OT EXCLUSIVE AND VO-7-OT STANDARD. THE UNIQUE PIVOT DESIGN OF THESE SHOWERS ALLOWS YOU EASILY MOVE THE SHOWER RAIN-BAR AWAY, KEEPING IT ALONG THE WALL WHEN NOT IN USE. THIS FEATURE MAKES TREATMENTS MUCH MORE COMFORTABLE FOR BOTH CLIENTS AND THERAPISTS.

BY PROVIDING TREATMENT PACKAGES AND MULTIPLE SERVICES IN THE SAME ROOM, SUCH A SET OF EQUIPMENT IS THE PERFECT SOLUTION FOR A LARGE SIZED OR SMALL SIZED DAY SPA. HAVING ALL-IN-ONE EQUIPMENT MAKES YOUR BUSINESS MUCH MORE PROFITABLE, SIGNIFICANTLY EXPANDS YOUR SERVICES AND IMPROVES CUSTOMER RETENTION. IT IS ALSO THE BEST SOLUTION FOR VIP HOME/ESTATE-BASED SPAS, WHERE ONE THERAPIST CAN PROVIDE PRACTICALLY ALL TYPES OF SPA SERVICES FOR

THE WHOLE FAMILY WITH THE HIGHEST QUALITY IN A COMPARATIVELY SMALL SPA FACILITY CONSISTING OF TWO OR THREE SMALL ROOMS ATTACHED TO THE POOL AREA OR THE WINTER GARDEN. THE FUNCTIONALITY OF SUCH A TREATMENT COMPLEX CAN BE EXPANDED EVEN MORE IF YOU PURCHASE THE AFFUSION/VICHY SHOWER WITH THE UNIVERSAL CONTROL PANEL AR-307. THIS DOES NOT REQUIRE EXTRA ROOM ON THE WALL, ADDING THE CONVENIENCE OF HAVING A SCOTCH HOSE/CHARCOT SHOWER TOGETHER WITH THE TUB IN THE SAME ROOM.

EXAMPLES OF HYDROTOP® WITH MATTRESS/HEAD SUPPORT PILLOW.

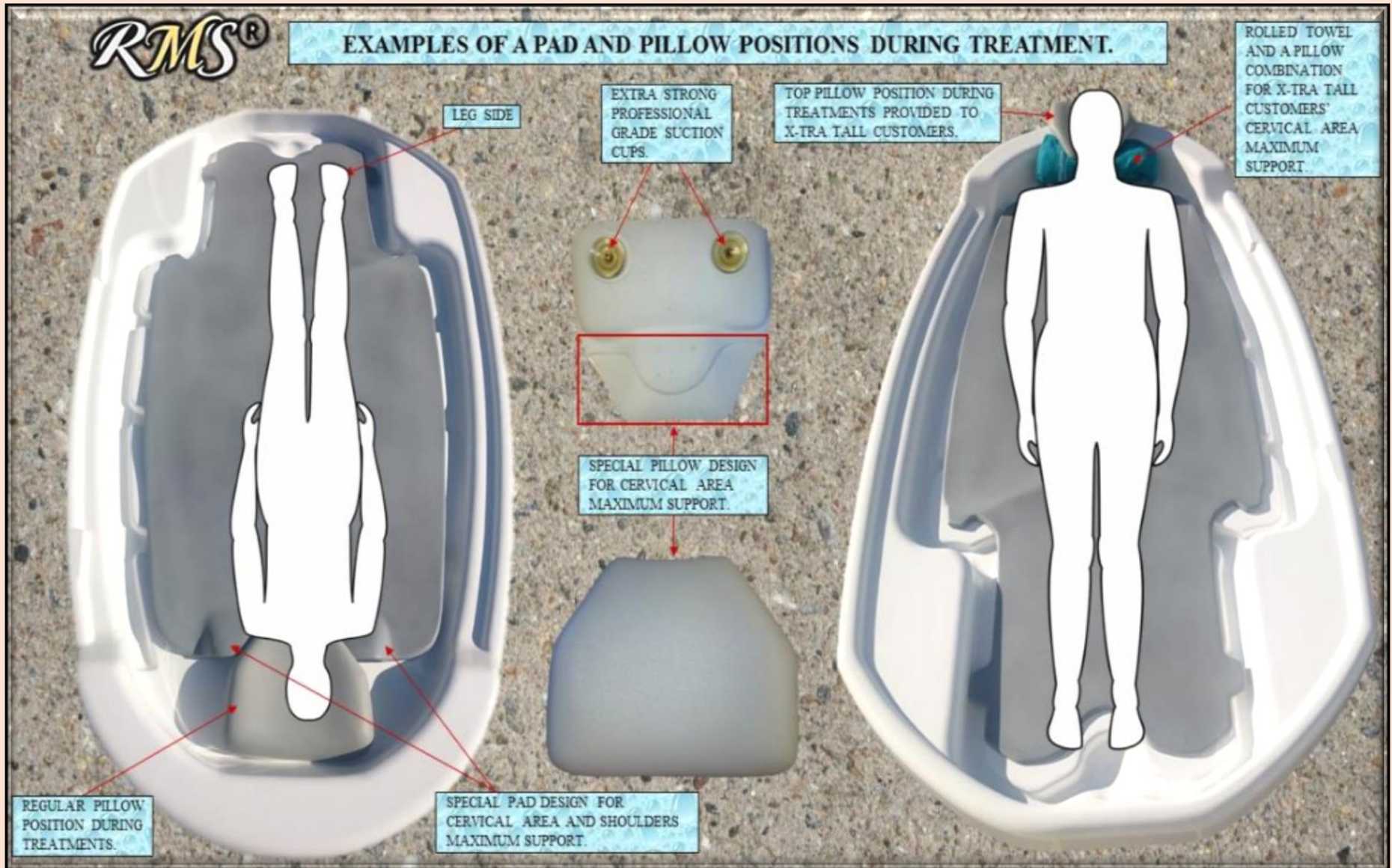







RMS®

EXAMPLES OF A PAD AND PILLOW POSITIONS DURING TREATMENT.



4.3 OPTIONAL “BASIC SET” OF UNDERWATER MASSAGE SYSTEM/EQUIPMENT *WITH PERMANENTLY ATTACHED HOSE/NOZZLE*
(CAN NOT BE DISCONNECTED/DETACHED BETWEEN TREATMENTS)

NOTE: UWM EQUIPMENT IS FULLY INSTALLED ON THE TUB DURING PRODUCTION.

#	PART#	PART DESCRIPTION	“BASIC SET #1” “BS” #1	“BASIC SET #2” “BS” #2	“BS” #1	“BS” #2
1	FLH-9 PERMANENTLY CONNECTED	PERMANENTLY CONNECTED UNDERWATER MASSAGE SPECIAL GRADE FLEX HOSE WITH BRASS CHROME PLATED FITTINGS.			PRESSURE UP TO 45 PSI/3 ATM	<i>NOTE: INCLUDES ADDITIONAL PRESSURE BOOSTING PUMP</i> CREATES WATER PRESSURE UP TO 90 PSI/6 ATM
2	N-04	SPECIAL UNDERWATER POINTED MASSAGE PLASTIC NOZZLE.				
3	HNH-CP	CHROME PLATED HOSE/NOZZLE HOLDER.				
4	T-PR-G	PRESSURE / TEMPERATURE GAUGE INTEGRATED INTO A SPECIAL HOUSING WITH CONNECTION FITTINGS.				
5	VLV-3/4	UNDERWATER MASSAGE SYSTEM BRASS CHROME PLATED CONTROL VALVE.				
6	UMSCB	UMSCB RMS® ELECTRONIC BOOSTER PUMP CONTROL BOX WITH TWO LEVELS OF SAFETY PROTECTION SYSTEM. INCLUDES: 2. WATER LEVEL SENSOR. 3. PRESSURE SENSOR WITH A SPECIAL IN LINE INSTALLATION FITTING. 4. AUDIO ALARM SYSTEM. 5. PNEUMATIC ON/OFF BUTTON. 6. UNIVERSAL SET OF HOOK-UP CABLES FOR BOOSTING PUMP CONNECTION. <i>NOTE: UMSCB PROTECTS BOOSTER PUMP FROM DRY RUN AND OVER- PRESSURE. CREATES SIMPLE, SAFE, USER-FRIENDLY SYSTEM OPERATION.</i>				
7	WPB-01	<i>ADDITIONAL PRESSURE BOOSTING PUMP FOR “BS” #8 ONLY</i>				

4.4 OPTIONAL UNDERWATER MASSAGE HOSE/HAND WAND SYSTEMS **QRS** AND **QRS SW** WITH DETACHABLE UNDERWATER MASSAGE HOSES.

SET#3 OPTIONAL SET OF UNDERWATER MASSAGE EQUIPMENT FOR JUMBO LINE X-TRA HYDROTHERAPY TUBS.
EQUIPMENT IS INSTALLED AT THE TIME OF PRODUCTION.
RMS® UNIQUE QUICK RELEASE HOSE SYSTEM.

1. SYSTEM ALLOWS TO ATTACH AND DETACH 2 MORE HOSE ASSEMBLIES WITH DIFFERENT TYPES OF NOZZLES IN LESS THAN 10 SECONDS OR TO DISCONNECT THE HOSE WHEN NOT IN USE.
2. BUILT-IN AUTOMATIC DOUBLE SHUT-OFF VALVE PREVENTS SPILL DURING CONNECT/DISCONNECT.
3. SET INCLUDES RMS® EXCLUSIVE ALL CHROME PLATED FITTINGS AND A NOZZLE/HOSE HOLDER.

UWM-RMS® QRS
UNIQUE QUICK LOCK ALL BRASS CHROME PLATED SET OF PRESSURE POINTED UNDERWATER MASSAGE SYSTEM EQUIPMENT INCLUDES THE FOLLOWING PARTS.

1. ALL BRASS AND CHROME ASSEMBLY:
 - 1.1 WATER PRESSURE/TEMPERATURE CONTROL GAUGE INSTALLED IN THE CUSTOM CHROME PLATED BODY.
 - 1.2 ALL CHROME PLATED BASE FOR THE GAUGE AND THE BODY.
 - 1.3 QRS (MESSAGE HOSE QUICK RELEASE SYSTEM) INTEGRATED INTO THE ABOVE ASSEMBLY.
 - 1.4 1PCS. OF A SPECIAL GRADE EXTRA FLEXIBLE AND EXTRA STRONG WHITE MESSAGE HOSE EQUIPPED WITH THE RESPONDING QUICK RELEASE CONNECTOR
2. AND A UNIQUE EXTRA LIGHT CHROME PLATED UNDERWATER PRESSURE MESSAGE NOZZLE #1.
2. BRASS CHROME PLATED DESIGNER'S SERIES EXTRA DUTY SHUT OFF VALVE.
3. ALL CHROME PLATED HOSE/NOSE ASSEMBLY HOLDER.
4. UMSCB RMS® ELECTRONIC BOOSTER PUMP CONTROL BOX WITH 2 LEVELS OF SAFETY PROTECTION SYSTEM INCLUDES:
 - 4.1 WATER LEVEL SENSOR.
 - 4.2 PRESSURE SENSOR WITH A SPECIAL IN LINE INSTALLATION FITTING.
 - 4.4 AUDIO ALARM SYSTEM.
 - 4.5 PNEUMATIC ON/OFF BUTTON.
 - 4.6 UNIVERSAL SET OF HOOK UP CABLES FOR BOOSTING PUMP CONNECTION.
 - 4.7 PUMP FOR CREATING UNDERWATER MASSAGE PRESSURE UP TO 45 PSI/ 3.1ATM.

NOTE: RMS® UMSCB SYSTEM PROTECTS THE PUMP FROM DRY RUN AND OVER-PRESSURE. IT CREATES SIMPLE, SAFE, USER FRIENDLY SYSTEM OPERATION. RMS® UMSCB COMPATIBLE WITH MOST TYPES OF PUMPS

SET#4 OPTIONAL SET OF UNDERWATER MASSAGE EQUIPMENT FOR JUMBO LINE X-TRA HYDROTHERAPY TUBS.
EQUIPMENT IS INSTALLED AT THE TIME OF PRODUCTION.
RMS® UNIQUE QUICK RELEASE HOSE SYSTEM.

1. SYSTEM ALLOWS TO ATTACH AND DETACH 2 MORE HOSE ASSEMBLIES WITH DIFFERENT TYPES OF NOZZLES IN LESS THAN 10 SECONDS OR TO DISCONNECT THE HOSE WHEN NOT IN USE.
2. BUILT-IN AUTOMATIC DOUBLE SHUT-OFF VALVE PREVENTS SPILL DURING CONNECT/DISCONNECT.
3. SET INCLUDES RMS® EXCLUSIVE ALL CHROME PLATED FITTINGS AND A NOZZLE/HOSE HOLDER.







UWM-RMS® QRS
UNIQUE QUICK LOCK ALL BRASS CHROME PLATED SET OF PRESSURE POINTED UNDERWATER MASSAGE SYSTEM EQUIPMENT INCLUDES THE FOLLOWING PARTS.

1. ALL BRASS AND CHROME ASSEMBLY:
 - 1.1 WATER PRESSURE/TEMPERATURE CONTROL GAUGE INSTALLED IN THE CUSTOM CHROME PLATED BODY.
 - 1.2 ALL CHROME PLATED BASE FOR THE GAUGE AND THE BODY.
 - 1.3 QRS (MESSAGE HOSE QUICK RELEASE SYSTEM) INTEGRATED INTO THE ABOVE ASSEMBLY.
 - 1.4 1PCS. OF A SPECIAL GRADE EXTRA FLEXIBLE AND EXTRA STRONG WHITE MESSAGE HOSE EQUIPPED WITH THE RESPONDING QUICK RELEASE CONNECTOR
2. AND A UNIQUE EXTRA LIGHT CHROME PLATED UNDERWATER PRESSURE MESSAGE NOZZLE #1.
2. BRASS CHROME PLATED DESIGNER'S SERIES EXTRA DUTY SHUT OFF VALVE.
3. ALL CHROME PLATED HOSE/NOSE ASSEMBLY HOLDER.
4. UMSCB RMS® ELECTRONIC BOOSTER PUMP CONTROL BOX WITH 2 LEVELS OF SAFETY PROTECTION SYSTEM INCLUDES:
 - 4.1 WATER LEVEL SENSOR.
 - 4.2 PRESSURE SENSOR WITH A SPECIAL IN LINE INSTALLATION FITTING.
 - 4.4 AUDIO ALARM SYSTEM.
 - 4.5 PNEUMATIC ON/OFF BUTTON.
 - 4.6 UNIVERSAL SET OF HOOK UP CABLES FOR BOOSTING PUMP CONNECTION.
 - 4.7 SPECIAL PUMP FOR CREATING UNDERWATER MASSAGE PRESSURE UP TO 95 PSI/6.8ATM.

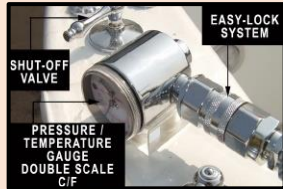
NOTE: RMS® UMSCB SYSTEM PROTECTS THE PUMP FROM DRY RUN AND OVER-PRESSURE. IT CREATES SIMPLE, SAFE, USER FRIENDLY SYSTEM OPERATION. RMS® UMSCB COMPATIBLE WITH MOST TYPES OF PUMPS

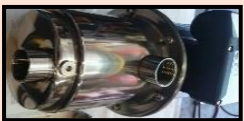
4.5 SPECIFICATIONS.

QRS AND QRS SW QUICK CONNECT UWM SYSTEMS.

SET#	PART #	UWM SETS DESCRIPTION.	NOTES
S#3	<p style="text-align: center;">QRS WATER PRESSURE UP TO 45 PSI/3 ATM <i>NO SWIVEL ACTION.</i></p>	<p>SPECIAL SET OF UNDERWATER MASSAGE EQUIPMENT WITH UNIQUE QUICK RELEASE SYSTEM (QRS) FOR UNDERWATER MASSAGE HOSE ATTACHMENT/DETACHMENT. ALLOWS CONNECTING/DISCONNECTING HAND WAND/MESSAGE HOSE ASSEMBLY TOGETHER WITH THE NOZZLE IN SECONDS. BUILT-IN AUTOMATIC DOUBLE SHUT-OFF VALVE TO PREVENT SPILL DURING CONNECT/DISCONNECT. SET INCLUDES THE FOLLOWING PARTS.</p> <p>1. ALL BRASS AND CHROME ASSEMBLY. 1.1 WATER PRESSURE/TEMPERATURE CONTROL GAUGE INSTALLED IN THE CUSTOM CHROME PLATED BODY. 1.2 ALL CHROME PLATED BASE FOR THE GAUGE AND THE BODY. 1.3 QRS (MESSAGE HOSE QUICK RELEASE SYSTEM) INTEGRATED INTO THE ABOVE ASSEMBLY. 1.4 SPECIAL GRADE EXTRA-FLEXIBLE AND EXTRA STRONG WHITE MESSAGE HOSE EQUIPPED WITH THE QUICK RELEASE RESPONDING CONNECTOR AND A UNIQUE EXTRA LIGHT CHROME PLATED UNDERWATER PRESSURE MASSAGE NOZZLE #1</p>	<p style="text-align: right;">QRS WATER PRESSURE UP TO 45 PSI/3 ATM <i>NO SWIVEL ACTION.</i></p>    
S#4	<p>QRS BP NO SWIVEL ACTION <i>INCLUDES ADDITIONAL BOOSTING PUMP</i> PRESSURE UP TO 90 PSI/6 ATM</p>  	<p>1.5 UMSCB RMS® ELECTRONIC BOOSTER PUMP CONTROL BOX WITH TWO LEVELS OF SAFETY PROTECTION SYSTEM. UMSCB (QRS BP) INCLUDES:</p> <ol style="list-style-type: none"> 1. WATER LEVEL SENSOR. 2. PRESSURE SENSOR WITH A SPECIAL IN LINE INSTALLATION FITTING. 3. AUDIO ALARM SYSTEM. 4. PNEUMATIC ON/OFF BUTTON. 5. UNIVERSAL SET OF HOOK UP CABLES FOR BOOSTING PUMP CONNECTION. <p><i>NOTE: UMSCB PROTECTS BOOSTER PUMP FROM DRY RUN AND OVER-PRESSURE. CREATES SIMPLE, SAFE, USER-FRIENDLY SYSTEM OPERATION.</i></p>	<p style="text-align: right;">QRS BP <i>INCLUDES ADDITIONAL BOOSTING PUMP</i> PRESSURE UP TO 90 PSI/6 ATM <i>NO SWIVEL ACTION.</i></p>    

SET#5 OPTIONAL SET OF UNDERWATER MASSAGE EQUIPMENT FOR JUMBO LINE X-TRA HYDROTHERAPY TUBS.

- EQUIPMENT IS INSTALLED AT THE TIME OF PRODUCTION.
 TAKE THE STRESS OFF YOUR BACK WITH
 RMS® UNIQUE SWIVEL QUICK RELEASE HOSE SYSTEM WITH EXCLUSIVE RMS® SWIVEL ACTION!
 1. UNIQUE SYSTEM DESIGN ALLOWS THE TUB OPERATOR TO PROVIDE TREATMENTS WITHOUT CARRING THE WEIGHT OF THE HOSE ALL DAY LONG. THE WHOLE HOSE ASSEMBLY ROTATES 360° EFFORTLESSLY IN ANY DIRECTION.
 2. IT PREVENTS HOSE KINKING AS WELL.
 3. SYSTEM ALLOWS TO ATTACH AND DETACH 2 MORE HOSE ASSEMBLIES WITH DIFFERENT TYPES OF NOZZLES IN LESS THAN 10 SECONDS.
 4. BUILT-IN AUTOMATIC DOUBLE SHUT-OFF VALVE PREVENTS SPILL DURING CONNCT/DISCONNECT.
 5. SET INCLUDES RMS® EXCLUSIVE ALL CHROME PLATED FITTINGS AND A NOZZLE HOSE HOLDER.

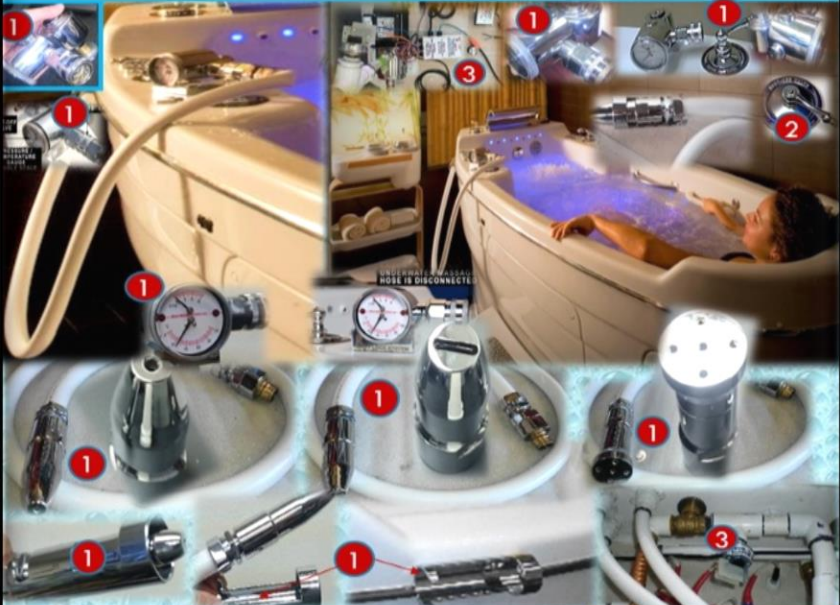

UWM-RMS®1 QRS SW UNIQUE QUICK LOCK ALL BRASS CHROME PLATED SET OF PRESSURE POINTED UNDERWATER MASSAGE SYSTEM INCLUDES THE FOLLOWING PARTS.

1. ALL BRASS AND CHROME ASSEMBLY:
- 1.1 WATER PRESSURE/TEMPERATURE CONTROL GAUGE INSTALLED IN THE CUSTOM CHROME PLATED BODY.
- 1.2 ALL CHROME PLATED BASE FOR THE GAUGE AND THE BODY.
- 1.3 ALL CHROME PLATED UNIQUE SWIVEL SYSTEM FOR THE ABOVE PARTS.
- 1.4 QRS (MESSAGE HOSE QUICK RELEASE SYSTEM) INTEGRATED INTO THE ABOVE ASSEMBLY.
- 1.5 1PCS. OF A SPECIAL GRADE EXTRA FLEXIBLE AND EXTRA STRONG WHITE MESSAGE HOSE EQUIPPED WITH THE RESPONDING QUICK RELEASE CONNECTOR AND THE UNIQUE EXTRA LIGHT CHROME PLATED UNDERWATER PRESSURE MESSAGE NOZZLE #1.
- 1.6 1PC. OF A SPECIAL GRADE EXTRA FLEXIBLE AND EXTRA STRONG WHITE MESSAGE HOSE EQUIPPED WITH THE RESPONDING QUICK RELEASE CONNECTOR AND THE UNIQUE EXTRA LIGHT CHROME PLATED UNDERWATER PRESSURE MESSAGE NOZZLE #2.
- 1.7 1PC. OF A SPECIAL GRADE EXTRA FLEXIBLE AND EXTRA STRONG WHITE MESSAGE HOSE EQUIPPED WITH THE RESPONDING QUICK RELEASE CONNECTOR AND THE UNIQUE EXTRA LIGHT CHROME PLATED UNDERWATER PRESSURE MESSAGE NOZZLE #3.
2. BRASS ALL CHROME PLATED DESIGNER'S SERIES EXTRA DUTY SHUT OFF VALVE.
3. ALL CHROME PLATED HOSE/NOSE ASSEMBLY HOLDER.
- UMSCB RMS® ELECTRONIC BOOSTER PUMP CONTROL BOX WITH 2 LEVELS OF SAFETY PROTECTION SYSTEM INCLUDES:
- 6.1 WATER LEVEL SENSOR.
- 6.2 PRESSURE SENSOR WITH A SPECIAL IN LINE INSTALLATION FITTING.
- 6.3 AUDIO ALARM SYSTEM.
- 6.4 PNEUMATIC ON/OFF BUTTON.
- 6.5 UNIVERSAL SET OF HOOK UP CABLES FOR BOOSTING PUMP CONNECTION.



6.6 PUMP FOR CREATING UNDERWATER MASSAGE PRESSURE UP TO 45 PSI/3ATM.

NOTE: RMS® UMSCB SYSTEM PROTECTS THE PUMP FROM DRY RUN AND OVER-PRESSURE. IT CREATES SIMPLE, SAFE, USER FRIENDLY SYSTEM OPERATION. RMS® UMSCB COMPATIBLE WITH MOST TYPES OF PUMPS.

SET#6 OPTIONAL SET OF UNDERWATER MASSAGE EQUIPMENT FOR JUMBO LINE X-TRA HYDROTHERAPY TUBS.

- EQUIPMENT IS INSTALLED AT THE TIME OF PRODUCTION.
 TAKE THE STRESS OFF YOUR BACK WITH
 RMS® UNIQUE SWIVEL QUICK RELEASE HOSE SYSTEM WITH EXCLUSIVE RMS® SWIVEL ACTION!
 1. UNIQUE SYSTEM DESIGN ALLOWS THE TUB OPERATOR TO PROVIDE TREATMENTS WITHOUT CARRING THE WEIGHT OF THE HOSE ALL DAY LONG. THE WHOLE HOSE ASSEMBLY ROTATES 360° EFFORTLESSLY IN ANY DIRECTION.
 2. IT PREVENTS HOSE KINKING AS WELL.
 3. SYSTEM ALLOWS TO ATTACH AND DETACH 2 MORE HOSE ASSEMBLIES WITH DIFFERENT TYPES OF NOZZLES IN LESS THAN 10 SECONDS.
 4. BUILT-IN AUTOMATIC DOUBLE SHUT-OFF VALVE PREVENTS SPILL DURING CONNCT/DISCONNECT.
 5. SET INCLUDES RMS® EXCLUSIVE ALL CHROME PLATED FITTINGS AND A NOZZLE HOSE HOLDER.











UWM-RMS®1 QRS SW UNIQUE QUICK LOCK ALL BRASS CHROME PLATED SET OF PRESSURE POINTED UNDERWATER MASSAGE SYSTEM INCLUDES THE FOLLOWING PARTS.

1. ALL BRASS AND CHROME ASSEMBLY:
- 1.1 WATER PRESSURE/TEMPERATURE CONTROL GAUGE INSTALLED IN THE CUSTOM CHROME PLATED BODY.
- 1.2 ALL CHROME PLATED BASE FOR THE GAUGE AND THE BODY.
- 1.3 ALL CHROME PLATED UNIQUE SWIVEL SYSTEM FOR THE ABOVE PARTS.
- 1.4 QRS (MESSAGE HOSE QUICK RELEASE SYSTEM) INTEGRATED INTO THE ABOVE ASSEMBLY.
- 1.5 1PCS. OF A SPECIAL GRADE EXTRA FLEXIBLE AND EXTRA STRONG WHITE MESSAGE HOSE EQUIPPED WITH THE RESPONDING QUICK RELEASE CONNECTOR AND THE UNIQUE EXTRA LIGHT CHROME PLATED UNDERWATER PRESSURE MESSAGE NOZZLE #1.
- 1.6 1PC. OF A SPECIAL GRADE EXTRA FLEXIBLE AND EXTRA STRONG WHITE MESSAGE HOSE EQUIPPED WITH THE RESPONDING QUICK RELEASE CONNECTOR AND THE UNIQUE EXTRA LIGHT CHROME PLATED UNDERWATER PRESSURE MESSAGE NOZZLE #2.
- 1.7 1PC. OF A SPECIAL GRADE EXTRA FLEXIBLE AND EXTRA STRONG WHITE MESSAGE HOSE EQUIPPED WITH THE RESPONDING QUICK RELEASE CONNECTOR AND THE UNIQUE EXTRA LIGHT CHROME PLATED UNDERWATER PRESSURE MESSAGE NOZZLE #3.
2. BRASS ALL CHROME PLATED DESIGNER'S SERIES EXTRA DUTY SHUT OFF VALVE.
3. ALL CHROME PLATED HOSE/NOSE ASSEMBLY HOLDER.
- UMSCB RMS® ELECTRONIC BOOSTER PUMP CONTROL BOX WITH 2 LEVELS OF SAFETY PROTECTION SYSTEM INCLUDES:
- 6.1 WATER LEVEL SENSOR.
- 6.2 PRESSURE SENSOR WITH A SPECIAL IN LINE INSTALLATION FITTING.
- 6.3 AUDIO ALARM SYSTEM.
- 6.4 PNEUMATIC ON/OFF BUTTON.
- 6.5 UNIVERSAL SET OF HOOK UP CABLES FOR BOOSTING PUMP CONNECTION.

















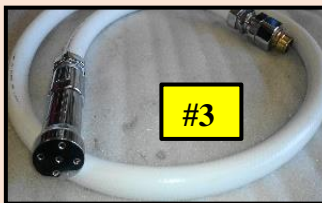





6.6 SPECIAL PUMP FOR CREATING UNDERWATER MASSAGE PRESSURE UP TO 95 PSI/6ATM.

NOTE: RMS® UMSCB SYSTEM PROTECTS THE PUMP FROM DRY RUN AND OVER-PRESSURE. IT CREATES SIMPLE, SAFE, USER FRIENDLY SYSTEM OPERATION. RMS® UMSCB COMPATIBLE WITH MOST TYPES OF PUMPS.

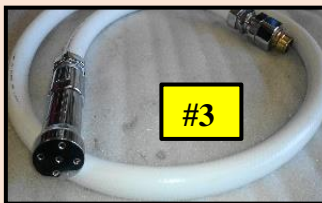





SET#	PART #	UWM SETS DESCRIPTION.		NOTES
S#5	<p>QRS SW1 WATER PRESSURE UP TO 45 PSI/3 ATM UNIQUE HOSE SWIVEL ACTION.</p> 	<p>UNDERWATER MASSAGE HOSE SWIVEL SET UNIQUE SYSTEM DESIGN ALLOWS THE TUB OPERATOR TO PROVIDE TREATMENTS WITHOUT CARRYING THE WEIGHT OF THE HOSE FILLED WITH WATER ALL DAY LONG. THE WHOLE HOSE ASSEMBLY ROTATES EFFORTLESSLY 360° IN ANY DIRECTION TOGETHER WITH THE OPERATOR MOVEMENT. IT PREVENTS HOSE KINKING AS WELL. THIS SYSTEM UPGRADE IS HIGHLY RECOMMENDED WHEN UNDERWATER MASSAGE HOSE IS CONSTANTLY IN USE. IT SIGNIFICANTLY REDUCES OPERATOR'S FATIGUE, IMPROVES THE TREATMENT QUALITY, ALLOWS THE OPERATOR TO CONCENTRATE ON THE TREATMENT QUALITY. BY ELIMINATING THE PROBLEM OF THE HOSE KINKING IT ALSO SIGNIFICANTLY EXTENDS THE HOSE LIFE. THE SWIVEL ACTION SYSTEM DOES NOT REQUIRE ANY MAINTENANCE.</p> <p>INCLUDES THE FOLLOWING PARTS. 1. ALL BRASS AND CHROME ASSEMBLY: 1.1 WATER PRESSURE/TEMPERATURE CONTROL GAUGE INSTALLED IN THE CUSTOM CHROME PLATED BODY. 1.2 ALL CHROME PLATED BASE FOR THE GAUGE AND THE BODY. 1.3 ALL CHROME PLATED UNIQUE SWIVEL SYSTEM FOR THE ABOVE PARTS. 1.4 QRS (MASSAGE HOSE QUICK RELEASE SYSTEM) INTEGRATED INTO THE ABOVE ASSEMBLY. 1.5 SPECIAL GRADE EXTRA-FLEXIBLE AND EXTRA STRONG WHITE MESSAGE HOSE EQUIPPED WITH THE QUICK RELEASE CORRESPONDING CONNECTOR AND A UNIQUE EXTRA LIGHT CHROME PLATED UNDERWATER MASSAGE NOZZLE #1. 1.6 UMCSB RMS® ELECTRONIC CONTROL BOX WITH TWO LEVELS OF SAFETY PROTECTION SYSTEM. - WATER LEVEL SENSOR. - PRESSURE SENSOR WITH A SPECIAL IN LINE INSTALLATION FITTING.</p>	  	<p>QRS SW1 WATER PRESSURE UP TO 45 PSI/3 ATM UNIQUE HOSE SWIVEL ACTION.</p>
S#6	<p>QRS SW1BP UNIQUE HOSE SWIVEL ACTION. INCLUDES ADDITIONAL BOOSTING PUMP</p>  <p>WATER PRESSURE UP TO 90 PSI/6 ATM</p>	<p>NOTE: UMCSB PROTECTS BOOSTER PUMP FROM DRY RUN AND OVER-PRESSURE. CREATES SIMPLE, SAFE, USER-FRIENDLY SYSTEM OPERATION.</p> <p>QRS SW1BP. SAME FUNCTIONS AS IN QRS SW1 INCLUDES ADDITION AL BOOSTING PUMP. CREATES WATER PRESSURE UP TO 90 PSI/6 ATM</p> 	 	<p>QRS SW1BP UNIQUE HOSE SWIVEL ACTION. INCLUDES ADDITIONAL BOOSTING PUMP CREATES WATER PRESSURE UP TO 90 PSI/6 ATM</p>

4.6 OPTIONAL UNDERWATER MASSAGE HOSE/HAND WAND SYSTEMS QRS SW WHICH INCLUDES ADDITIONAL SET OF HOSES WITH 3PCS. DIFFERENT TYPES OF UNDERWATER MASSAGE NOZZLES. UNIQUE DESIGN OF THE SYSTEM ALLOWS TO CHANGE THE HOSE WITH THE NOZZLE WITHIN 10 SECONDS WITHOUT INTERRUPTING THE TREATMENT.

SET#	PART #	SET DESCRIPTION.			NOTES
S#7	<p>QRS SW2 PRESSURE UP TO 45 PSI/3 ATM <i>UNIQUE HOSE SWIVEL ACTION. EXTRA SET OF HOSES WITH 3PCS. DIFFERENT TYPES OF NOZZLES FOR DIFFERENT TYPES OF TREATMENTS.</i></p>	<p>UNDERWATER MASSAGE HOSE SWIVEL SET UNIQUE SYSTEM DESIGN ALLOWS THE TUB OPERATOR TO PROVIDE TREATMENTS WITHOUT CARRYING THE WEIGHT OF THE HOSE FILLED WITH WATER ALL DAY LONG. THE WHOLE HOSE ASSEMBLY ROTATES EFFORTLESSLY 360° IN ANY DIRECTION TOGETHER WITH THE OPERATOR MOVEMENT. IT PREVENTS HOSE KINKING AS WELL. THIS SYSTEM UPGRADE IS HIGHLY RECOMMENDED WHEN UNDERWATER MASSAGE HOSE IS CONSTANTLY IN USE. IT SIGNIFICANTLY REDUCES OPERATOR'S FATIGUE, IMPROVES THE TREATMENT QUALITY, ALLOWS THE OPERATOR TO CONCENTRATE ON THE TREATMENT QUALITY. BY ELIMINATING THE PROBLEM OF THE HOSE KINKING IT ALSO SIGNIFICANTLY EXTENDS THE HOSE LIFE. THE SWIVEL ACTION SYSTEM DOES NOT REQUIRE ANY MAINTENANCE.</p>			<p>QRS SW2 PRESSURE UP TO 45 PSI/3 ATM <i>UNIQUE HOSE SWIVEL ACTION. EXTRA SET OF HOSES WITH 3PCS. DIFFERENT TYPES OF NOZZLES FOR DIFFERENT TYPES OF TREATMENTS.</i></p>
S#8	<p>QRS SW2BP <i>INCLUDES ADDITIONAL PRESSURE BOOSTING PUMP.</i> <i>UNIQUE HOSE SWIVEL ACTION. EXTRA SET OF HOSES WITH 3PCS. DIFFERENT TYPES OF</i></p>  <p><i>NOZZLES FOR DIFFERENT TYPES OF TREATMENTS.</i></p> <p>CREATES PRESSURE UP TO 90 PSI/6 ATM</p> 	<p>INCLUDES THE FOLLOWING PARTS.</p> <ol style="list-style-type: none"> 1. ALL BRASS AND CHROME ASSEMBLY: <ol style="list-style-type: none"> 1.1 WATER PRESSURE/TEMPERATURE CONTROL GAUGE INSTALLED IN THE CUSTOM CHROME PLATED BODY. 1.2 ALL CHROME PLATED BASE FOR THE GAUGE AND THE BODY. 1.3 ALL CHROME PLATED UNIQUE SWIVEL SYSTEM FOR THE ABOVE PARTS. 1.4 QRS (MESSAGE HOSE QUICK RELEASE SYSTEM) INTEGRATED INTO THE ABOVE ASSEMBLY. 1.5 SPECIAL GRADE EXTRA-FLEXIBLE AND EXTRA STRONG WHITE MESSAGE HOSES EQUIPPED WITH THE QUICK RELEASE RESPONDING CONNECTOR AND HOSES WITH UNIQUE EXTRA LIGHT CHROME PLATED UNDERWATER PRESSURE MASSAGE NOZZLES #1, #2, #3 1.6 UMCSB RMS® ELECTRONIC CONTROL BOX WITH TWO LEVELS OF SAFETY PROTECTION SYSTEM. <ul style="list-style-type: none"> - WATER LEVEL SENSOR. - PRESSURE SENSOR WITH A SPECIAL IN LINE INSTALLATION FITTING.          	   	   	<p>QRS SW2BP <i>INCLUDES ADDITIONAL PRESSURE BOOSTING PUMP. CREATES WATER PRESSURE UP TO 90 PSI/6 ATM</i> <i>UNIQUE HOSE SWIVEL ACTION. EXTRA SET OF HOSES WITH 3PCS. DIFFERENT TYPES OF NOZZLES FOR DIFFERENT TYPES OF TREATMENTS.</i></p>

4.7 ADDITIONAL SETS OF ASSEMBLY HOSES AND NOZZLES FOR QRS UNDERWATER MASSAGE SYSTEM.

WITH RMS® QRS SYSTEM YOU CAN USE 3 DIFFERENT TYPES OF NOZZLES FOR DIFFERENT TYPES OF UNDERWATER MASSAGE TREATMENTS. GROW YOUR BUSINESS! YOUR CUSTOMERS WILL APPRECIATE IT; CUSTOMER RETENTION WILL BE IMPROVED. EXPAND YOUR SPA MENU, ADD TWO MORE NOZZLES AND MANY NEW TREATMENTS.

#	PART #	SET DESCRIPTION.	PHOTO	NOTES
1	QRS H/N SET 1 AVAILABLE FOR TUBS EQUIPPED WITH QRS SYSTEM ALL BRASS AND CHROME SYSTEM.	SET 1 ADDITIONAL SET OF A HOSE AND A NOZZLE. ALLOWS TO CHANGE THE BASIC HOSE TOGETHER WITH THE NOZZLE FOR ANOTHER TYPE OF NOZZLE IN LESS THAN 10 SECONDS FOR PROVIDING DIFFERENT TYPES OF UNDERWATER PRESSURE MASSAGE.		
2	QRS H/N SET 2 AVAILABLE FOR TUBS EQUIPPED WITH QRS SYSTEM ALL BRASS AND CHROME SYSTEM.	SET 2 ADDITIONAL SET OF A HOSE AND A NOZZLE. ALLOWS TO CHANGE THE BASIC HOSE TOGETHER WITH THE NOZZLE FOR ANOTHER TYPE OF NOZZLE IN LESS THAN 10 SECONDS FOR PROVIDING DIFFERENT TYPES OF UNDERWATER PRESSURE MASSAGE.		
3	NS-03 CP ALL BRASS AND CHROME SYSTEM.	COMPLETE SET OF NOZZLES (3PCS.) EXCLUSIVE EXTRA LIGHT CHROME PLATED NOZZLE SET FOR UNDERWATER MASSAGE HOSE. NOZZLES FIT ANY RMS® UNDERWATER MASSAGE OR SCOTCH HOSE/CHARCOT SHOWER HOSES.		
4	NZ-01 ALL BRASS AND CHROME SYSTEM.	NOZZLE #1 NOZZLE FITS ANY RMS® UNDERWATER MASSAGE OR SCOTCH HOSE/CHARCOT SHOWER HOSES.		
5	NZ-02 ALL BRASS AND CHROME SYSTEM.	NOZZLE #2 NOZZLE FITS ANY RMS® UNDERWATER MASSAGE OR SCOTCH HOSE/CHARCOT SHOWER HOSES		
6	NZ-03 ALL BRASS AND CHROME SYSTEM.	NOZZLE #3 NOZZLE FITS ANY RMS® UNDERWATER MASSAGE OR SCOTCH HOSE/CHARCOT SHOWER HOSES		
7	NZ-04	NOZZLE #4 NOZZLE FITS ANY RMS® UNDERWATER MASSAGE OR SCOTCH HOSE/CHARCOT SHOWER HOSES		



4.8.1 "VO-7-OT EXCLUSIVE" SERIES WITH 180° SWIVEL BASE
14 PCS. SHOWER HEADS.



#	SET DESCRIPTION.	NOTES
1	<p>«VO-7 SW-OT EXCLUSIVE PREMIUM CHROME» EXTRA COMPACT DESIGN, SHIPS UPS/FEDEX. SIMPLE QUICK INSTALLATION AND HOOK UP.</p> <p>1. SHOWER RAIN BAR EXTENDED W/7 CROSSBAR MANIFOLDS (14PCS. SHOWER HEADS) FINISH: "POLISHED CHROME." 1PC.</p> <p>2. SHOWER HEADS/WATER INJECTORS (SPECIAL DESIGN) WITH TEN WATER CHANNELS EACH, WITH AN INDIVIDUAL ON/OFF FROM FOREST RAIN TO TROPICAL MIST AND SWIVEL ACTION TO ANY POSITION. EQUIPPED WITH AN INDIVIDUAL ON/OFF BUTTON. FINISH: "CHROME." 14PCS.</p> <p>3. INTEGRATED 180° RAIN BAR SWIVEL SYSTEM 1PC.</p> <p>4. CR/VOAB-P MOLDED ACRYLIC HANG ON THE WALL UNIVERSAL CONTROL PANEL INCLUDES 1PC. -MAIN ON/OFF VALVE -COLD WATER VALVE -HOT WATER VALVE -TEMPERATURE/PRESSURE GAUGE -HAND SHOWER FOR RINSING -HAND SHOWER HOLDER (CHROME PLATED) -INDIVIDUAL CONTROL VALVE FOR THE HAND SHOWER</p> <p>5. ACRYLIC SCREEN FOR FACE PROTECTION WITH DECO MOLDINGS 1PC.</p> <p>6. SPECIAL ACRYLIC OVAL BOXES VOAB-1, VOAB-2 FOR VICHY SHOWER WALL MOUNTING 2PCS.</p>	
2	<p>«VO-7 SW-OT EXCLUSIVE ECONOMY 1 CHROME» NEW EXTRA COMPACT DESIGN, SHIPS UPS/FEDEX. SIMPLE QUICK INSTALLATION AND HOOK UP.</p> <p>1. SHOWER RAIN BAR EXTENDED W/ SEVEN CROSSBAR MANIFOLDS (14PCS. SHOWER HEADS) FINISH: "POLISHED CHROME." 1PC.</p> <p>2. SHOWER HEADS/WATER INJECTORS (SPECIAL DESIGN) WITH TEN WATER CHANNELS EACH, WITH AN INDIVIDUAL ON/OFF FROM FOREST RAIN TO TROPICAL MIST AND SWIVEL ACTION TO ANY POSITION. EQUIPPED WITH AN INDIVIDUAL ON/OFF BUTTON. FINISH: "CHROME." 14PCS.</p> <p>3. INTEGRATED 180° RAIN BAR SWIVEL SYSTEM 1PC.</p> <p>4. CR/VOAB-E1 MOLDED ACRYLIC HANG ON THE WALL UNIVERSAL CONTROL PANEL INCLUDES 1PC. -MAIN ON/OFF VALVE -COLD WATER VALVE -HOT WATER VALVE -TEMPERATURE/PRESSURE GAUGE</p> <p>5. ACRYLIC SCREEN FOR FACE PROTECTION WITH DECO MOLDINGS 1PC.</p> <p>6. SPECIAL ACRYLIC OVAL BOXES VOAB-1, VOAB-2 FOR VICHY SHOWER WALL MOUNTING 2PCS.</p>	
3	<p>«VO-7 SW-OT EXCLUSIVE ECONOMY 2 CHROME» NEW EXTRA COMPACT DESIGN, SHIPS UPS/FEDEX. SIMPLE QUICK INSTALLATION AND HOOK UP.</p> <p>1. SHOWER RAIN BAR EXTENDED W/7 CROSSBAR MANIFOLDS (14PCS. SHOWER HEADS) FINISH: "POLISHED CHROME." 1PC.</p> <p>2. SHOWER HEADS/WATER INJECTORS (SPECIAL DESIGN) WITH TEN WATER CHANNELS EACH, W/ADJUSTABLE PRESSURE FROM FOREST RAIN TO TROPICAL MIST AND SWIVEL ACTION TO ANY POSITION. EQUIPPED WITH AN INDIVIDUAL ON/OFF BUTTON. FINISH: "CHROME." 14PCS.</p> <p>3. INTEGRATED 180° RAIN BAR SWIVEL SYSTEM 1PC.</p> <p>4. CR/VOAB-E2 MOLDED ACRYLIC HANG ON THE WALL UNIVERSAL CONTROL PANEL INCLUDES 1PC. -MAIN ON/OFF VALVE -COLD WATER VALVE -HOT WATER VALVE</p> <p>5. ACRYLIC SCREEN FOR FACE PROTECTION WITH DECO MOLDINGS 1PC.</p> <p>6. SPECIAL ACRYLIC OVAL BOXES VOAB-1, VOAB-2 FOR VICHY SHOWER WALL MOUNTING 2PCS.</p>	

4	<p>«VO-7 SW-OT EXCLUSIVE BASIC CHROME» NEW EXTRA COMPACT DESIGN, SHIPS UPS/FEDEX. SIMPLE QUICK INSTALLATION AND HOOK UP.</p> <p>1. SHOWER RAIN BAR EXTENDED W/7 CROSSBAR MANIFOLDS (14PCS. SHOWER HEADS) FINISH: "POLISHED CHROME." 1PC.</p> <p>2. SHOWER HEADS/WATER INJECTORS (SPECIAL DESIGN) WITH TEN WATER CHANNELS EACH, W/ADJUSTABLE PRESSURE FROM FOREST RAIN TO TROPICAL MIST AND SWIVEL ACTION TO ANY POSITION. EQUIPPED WITH AN INDIVIDUAL ON/OFF BUTTON. FINISH: "CHROME." 14PCS.</p> <p>3. INTEGRATED 180° RAIN BAR SWIVEL SYSTEM 1PC.</p> <p>4. MAIN ON/OFF VALVE 1PC.</p> <p>5. COLD WATER VALVE 1PC.</p> <p>6. HOT WATER VALVE 1PC.</p> <p>7. ACRYLIC SCREEN FOR FACE PROTECTION WITH DECO MOLDINGS 1PC.</p> <p>8. SPECIAL ACRYLIC OVAL BOXES VOAB-1, VOAB-2 FOR VICHY SHOWER WALL MOUNTING</p>	
<p>EXCLUSIVE VICHY SHOWER MODELS WITH EXTRA POWERFULL AUTOMATIC WATER TEMPERATURE CONTROL SYSTEM. BOTH MODELS HAVE A SPECIAL TYPE OF A CONTROL BOX WHICH CAN BE INSTALLED REMOTELY AT ANY PLACE IN THE ROOM FOR ADDITIONAL OPERATOR CONVENIENCE. THE CONTROL BOXES CAN BE ALSO EQUIPPED WITH AN OPTIONAL SCOTCH HOSE/CHARCOT SHOWER SYSTEM FOR PROVIDING POINTED PRESSURE CHARCOT SHOWER MASSAGE.</p>		
5	<p>VICHY SHOWER "VO-7-OT EXCLUSIVE GOLD"</p> <p>1. EXTENDED SHOWER RAIN BAR WITH SEVEN CROSSBAR MANIFOLDS (14PCS. SHOWER HEADS) AND SPECIAL SUPPORT SYSTEM. FINISH: "POLISHED GOLD." 1PC.</p> <p>2. SHOWER HEADS/WATER INJECTORS (SPECIAL DESIGN) WITH TEN WATER CHANNELS EACH, W/ADJUSTABLE PRESSURE FROM FOREST RAIN TO TROPICAL MIST AND SWIVEL ACTION TO ANY POSITION. EQUIPPED WITH AN INDIVIDUAL ON/OFF BUTTON. FINISH: "POLISHED GOLD." 14PCS.</p> <p>3. INTEGRATED 180° RAIN BAR SWIVEL SYSTEM 1PC.</p> <p>4. DR -200 BGV MOLDED ACRYLIC HANG ON THE WALL UNIVERSAL CONTROL PANEL INCLUDES: 1PC.</p> <p>-AUTOMATIC THERMIXER X-200, -MAIN ON/OFF VALVE -TEMPERATURE/PRESSURE GAUGE</p> <p>5. ACRYLIC SCREEN FOR FACE PROTECTION WITH DECO MOLDINGS 1PC.</p> <p>6. SPECIAL ACRYLIC OVAL BOXES VOAB-1, VOAB-2 FOR VICHY SHOWER WALL MOUNTING 2PC.</p> <p>7. DECO SCREENS</p> <p>NOTE: THIS MODEL ALLOWS TO INSTALL CONTROL PANEL REMOTELY UPON CUSTOMER'S CHOICE.</p>	
<p>OPTION: THIS MODEL CAN BE EQUIPPED WITH SCOTCH HOSE/CHARCOT SHOWER HOSE-1PC. WITH INDIVIDUAL CONTROL VALVE FOR POINTED PRESSURE MASSAGE.</p>		
6	<p>VICHY SHOWER "VO-7-OT EXCLUSIVE CHROME"</p> <p>1. EXTENDED SHOWER RAIN-BAR WITH SEVEN CROSSBAR MANIFOLDS (14PCS. SHOWER HEADS) AND SPECIAL SUPPORT SYSTEM. FINISH: "POLISHED CHROME." 1PC.</p> <p>2. SHOWER HEADS/WATER INJECTORS (SPECIAL DESIGN) WITH TEN WATER CHANNELS EACH, W/ADJUSTABLE PRESSURE FROM FOREST RAIN TO TROPICAL MIST AND SWIVEL ACTION TO ANY POSITION. EQUIPPED WITH AN INDIVIDUAL ON/OFF BUTTON. FINISH: "CHROME." 14PCS.</p> <p>3. INTEGRATED 180° RAIN BAR SWIVEL SYSTEM 1PC.</p> <p>4. DR -200 BGV MOLDED ACRYLIC HANG ON THE WALL UNIVERSAL CONTROL PANEL INCLUDES: 1PC.</p> <p>-AUTOMATIC THERMIXER X-200, -MAIN ON/OFF VALVE -TEMPERATURE/PRESSURE GAUGE</p> <p>5. ACRYLIC SCREEN FOR FACE PROTECTION WITH DECO MOLDINGS 1PC.</p> <p>6. SPECIAL ACRYLIC OVAL BOXES VOAB-1, VOAB-2 FOR VICHY SHOWER WALL MOUNTING 2PCS.</p> <p>7. DECO SCREENS</p> <p>NOTE: THIS MODEL ALLOWS TO INSTALL CONTROL PANEL REMOTELY UPON CUSTOMER'S CHOICE</p>	
<p>OPTION: THIS MODEL CAN BE EQUIPPED WITH SCOTCH HOSE/CHARCOT SHOWER HOSE-1PC. WITH INDIVIDUAL CONTROL VALVE FOR POINTED PRESSURE MASSAGE.</p>		



4.8.2 "VO-7 SW-OT STANDARD" SERIES WITH 180° SWIVEL BASE.
7 PCS. SHOWER HEADS.



#	SET DESCRIPTION.	NOTES
1	<p>«VO-7 SW-OT STANDARD PREMIUM PLUS CHROME» <i>EXTRA COMPACT DESIGN, SHIPS UPS/FEDEX. SIMPLE QUICK INSTALLATION.</i></p> <p>1. SHOWER RAIN BAR EXTENDED WITH 7PCS. SHOWER HEADS. FINISH: "POLISHED CHROME." 1PC.</p> <p>2. SHOWER HEADS/WATER INJECTORS (SPECIAL DESIGN) WITH TEN WATER CHANNELS EACH, W/ADJUSTABLE PRESSURE FROM FOREST RAIN TO TROPICAL MIST AND SWIVEL ACTION TO ANY POSITION. EQUIPPED WITH AN INDIVIDUAL ON/OFF BUTTON. FINISH: "CHROME." 7PCS.</p> <p>3. INTEGRATED 180° RAIN BAR SWIVEL SYSTEM 1PC.</p> <p>4. CR/VOAB-P MOLDED ACRYLIC HANG ON THE WALL UNIVERSAL CONTROL PANEL INCLUDES 1PC.</p> <ul style="list-style-type: none"> - MAIN ON/OFF VALVE - AUTOMATIC WATER TEMPERATURE CONTROL SYSTEM 1PC. - TEMPERATURE/PRESSURE GAUGE - HAND SHOWER FOR RINSING - HAND SHOWER HOLDER (CHROME PLATED) - INDIVIDUAL CONTROL VALVE FOR THE HAND SHOWER <p>5. ACRYLIC SCREEN FOR FACE PROTECTION WITH DECO MOLDINGS 1PC.</p> <p>6. SPECIAL ACRYLIC OVAL BOXES VOAB-1, VOAB-2 FOR VICHY SHOWER WALL MOUNTING 2PCS.</p>	
2	<p>«VO-7 SW-OT STANDARD PREMIUM CHROME» <i>EXTRA COMPACT DESIGN, SHIPS UPS/FEDEX. SIMPLE QUICK INSTALLATION.</i></p> <p>1. SHOWER RAIN BAR EXTENDED WITH 7PCS. SHOWER HEADS. FINISH: "POLISHED CHROME." 1PC.</p> <p>2. SHOWER HEADS/WATER INJECTORS (SPECIAL DESIGN) WITH TEN WATER CHANNELS EACH, W/ADJUSTABLE PRESSURE FROM FOREST RAIN TO TROPICAL MIST AND SWIVEL ACTION TO ANY POSITION. EQUIPPED WITH AN INDIVIDUAL ON/OFF BUTTON. FINISH: "CHROME." 7PCS.</p> <p>3. INTEGRATED 180° RAIN BAR SWIVEL SYSTEM 1PC.</p> <p>4. CR/VOAB-P MOLDED ACRYLIC HANG ON THE WALL UNIVERSAL CONTROL PANEL INCLUDES 1PC.</p> <ul style="list-style-type: none"> - MAIN ON/OFF VALVE - COLD WATER VALVE - HOT WATER VALVE - TEMPERATURE/PRESSURE GAUGE - HAND SHOWER FOR RINSING - HAND SHOWER HOLDER (CHROME PLATED) - INDIVIDUAL CONTROL VALVE FOR THE HAND SHOWER <p>5. ACRYLIC SCREEN FOR FACE PROTECTION WITH DECO MOLDINGS 1PC.</p> <p>6. SPECIAL ACRYLIC OVAL BOXES VOAB-1, VOAB-2 FOR VICHY SHOWER WALL MOUNTING 2PCS.</p>	
3	<p>«VO-7 SW-OT STANDARD ECONOMY 1 CHROME» <i>EXTRA COMPACT DESIGN, SHIPS UPS/FEDEX. SIMPLE QUICK INSTALLATION.</i></p> <p>1. SHOWER RAIN BAR EXTENDED WITH 7PCS. SHOWER HEADS. FINISH: "POLISHED CHROME." 1PC.</p> <p>2. SHOWER HEADS/WATER INJECTORS (SPECIAL DESIGN) WITH TEN WATER CHANNELS EACH, W/ADJUSTABLE PRESSURE FROM FOREST RAIN TO TROPICAL MIST AND SWIVEL ACTION TO ANY POSITION. EQUIPPED WITH AN INDIVIDUAL ON/OFF BUTTON. FINISH: "CHROME." 7PCS.</p> <p>3. INTEGRATED 180° RAIN BAR SWIVEL SYSTEM 1PC.</p> <p>4. CR/VOAB-E1 MOLDED ACRYLIC HANG ON THE WALL UNIVERSAL CONTROL PANEL INCLUDES 1PC.</p> <ul style="list-style-type: none"> - MAIN ON/OFF VALVE - COLD WATER VALVE - HOT WATER VALVE - TEMPERATURE/PRESSURE GAUGE <p>5. ACRYLIC SCREEN FOR FACE PROTECTION WITH DECO MOLDINGS 1PC.</p> <p>6. SPECIAL ACRYLIC OVAL BOXES VOAB-1, VOAB-2 FOR VICHY SHOWER WALL MOUNTING 2PCS.</p>	

4	<p>«VO-7 SW-OT STANDARD ECONOMY 2 CHROME» EXTRA COMPACT DESIGN, SHIPS UPS/FEDEX. SIMPLE QUICK INSTALLATION.</p> <p>1. SHOWER RAIN BAR EXTENDED WITH 7PCS. SHOWER HEADS. FINISH: "POLISHED CHROME." 1PC.</p> <p>2. SHOWER HEADS/WATER INJECTORS (SPECIAL DESIGN) WITH TEN WATER CHANNELS EACH, W/ADJUSTABLE PRESSURE FROM FOREST RAIN TO TROPICAL MIST AND SWIVEL ACTION TO ANY POSITION. EQUIPPED WITH AN INDIVIDUAL ON/OFF BUTTON. FINISH: "CHROME." 7PCS.</p> <p>3. INTEGRATED 180° RAIN BAR SWIVEL SYSTEM 1PC.</p> <p>4. CR/VOAB-E2 MOLDED ACRYLIC HANG ON THE WALL UNIVERSAL CONTROL PANEL INCLUDES 1PC.</p> <ul style="list-style-type: none"> - MAIN ON/OFF VALVE - COLD WATER VALVE - HOT WATER VALVE <p>5. ACRYLIC SCREEN FOR FACE PROTECTION WITH DECO MOLDINGS 1PC.</p> <p>6. SPECIAL ACRYLIC OVAL BOXES VOAB-1, VOAB-2 FOR VICHY SHOWER WALL MOUNTING.</p>	
5	<p>«VO-7 SW-OT STANDARD BASIC CHROME» EXTRA COMPACT DESIGN, SHIPS UPS/FEDEX. SIMPLE QUICK INSTALLATION AND HOOK UP.</p> <p>1. SHOWER RAIN BAR EXTENDED WITH 7PCS. SHOWER HEADS. FINISH: "POLISHED CHROME." 1PC.</p> <p>2. SHOWER HEADS/WATER INJECTORS (SPECIAL DESIGN) WITH TEN WATER CHANNELS EACH, W/ADJUSTABLE PRESSURE FROM FOREST RAIN TO TROPICAL MIST AND SWIVEL ACTION TO ANY POSITION. EQUIPPED WITH AN INDIVIDUAL ON/OFF BUTTON. FINISH: "CHROME." 7PCS.</p> <p>3. INTEGRATED 180° RAIN BAR SWIVEL SYSTEM 1PC.</p> <p>4. MAIN ON/OFF VALVE 1PC.</p> <p>5. COLD WATER VALVE 1PC.</p> <p>6. HOT WATER VALVE</p> <p>7. ACRYLIC SCREEN FOR FACE PROTECTION WITH DECO MOLDINGS 1PC.</p> <p>8. SPECIAL ACRYLIC OVAL BOXES VOAB-1, VOAB-2 FOR VICHY SHOWER WALL MOUNTING. 2PCS.</p>	
<p>EXCLUSIVE VICHY SHOWER MODELS WITH EXTRA POWERFULL AUTOMATIC WATER TEMPERATURE CONTROL SYSTEM. BOTH MODELS HAVE A SPECIAL TYPE OF A CONTROL BOX WHICH CAN BE INSTALLED REMOTELY AT ANY PLACE IN THE ROOM FOR ADDITIONAL OPERATOR CONVENIENCE. THE CONTROL BOXES CAN BE ALSO EQUIPPED WITH AN OPTIONAL SCOTCH HOSE/CHARCOT SHOWER SYSTEM FOR PROVIDING POINTED PRESSURE CHARCOT SHOWER MASSAGE.</p>		
6	<p>VICHY SHOWER «VO-7-OT STANDARD GOLD»</p> <p>1. EXTENDED SHOWER RAIN BAR WITH 7PCS. SHOWER HEADS AND SPECIAL SUPPORT SYSTEM. FINISH: "POLISHED GOLD." 1PC.</p> <p>2. SHOWER HEADS/WATER INJECTORS (SPECIAL DESIGN) WITH TEN WATER CHANNELS EACH, W/ADJUSTABLE PRESSURE FROM FOREST RAIN TO TROPICAL MIST AND SWIVEL ACTION TO ANY POSITION. EQUIPPED WITH AN INDIVIDUAL ON/OFF BUTTON. FINISH: "POLISHED GOLD." 7PCS.</p> <p>3. INTEGRATED 180° RAIN BAR SWIVEL SYSTEM 1PC.</p> <p>4. DR-130 BGV MOLDED ACRYLIC HANG ON THE WALL UNIVERSAL CONTROL PANEL INCLUDES 1PC.</p> <ul style="list-style-type: none"> - AUTOMATIC THERMIXER X-130, - MAIN ON/OFF VALVE - TEMPERATURE/PRESSURE GAUGE <p>5. ACRYLIC SCREEN FOR FACE PROTECTION WITH DECO MOLDINGS 1PC.</p> <p>6. SPECIAL ACRYLIC OVAL BOXES VOAB-1, VOAB-2 FOR VICHY SHOWER WALL MOUNTING 2PCS.</p> <p>7. DECO SCREENS</p> <p>NOTE: THIS MODEL ALLOWS TO INSTALL CONTROL PANEL REMOTELY UPON CUSTOMER'S CHOICE</p>	
<p>OPTION: THIS MODEL CAN BE EQUIPPED WITH SCOTCH HOSE/CHARCOT SHOWER HOSE-1PC. WITH INDIVIDUAL CONTROL VALVE FOR POINTED PRESSURE MASSAGE.</p>		







7	<p>VICHY SHOWER “VO-7-OT STANDARD CHROME”</p> <p>1. EXTENDED SHOWER RAIN BAR WITH 7PCS. SHOWER HEADS AND SPECIAL SUPPORT SYSTEM FINISH: “POLISHED CHROME.”</p> <p style="text-align: right;">1PC.</p> <p>2. SHOWER HEADS/WATER INJECTORS (SPECIAL DESIGN) WITH TEN WATER CHANNELS EACH, W/ADJUSTABLE PRESSURE FROM FOREST RAIN TO TROPICAL MIST AND SWIVEL ACTION TO ANY POSITION. EQUIPPED WITH AN INDIVIDUAL ON/OFF BUTTON. FINISH: “CHROME.”</p> <p style="text-align: right;">7PCS.</p> <p>3. INTEGRATED 180° RAIN BAR SWIVEL SYSTEM.</p> <p style="text-align: right;">1PC.</p> <p>4. DR-130 BGV MOLDED ACRYLIC HANG ON THE WALL UNIVERSAL CONTROL PANEL INCLUDES - AUTOMATIC THERMIXER X-130, - MAIN ON/OFF VALVE - TEMPERATURE/PRESSURE GAUGE</p> <p style="text-align: right;">1PC.</p> <p>5. ACRYLIC SCREEN FOR FACE PROTECTION WITH DECO MOLDINGS</p> <p style="text-align: right;">1PC.</p> <p>6. SPECIAL ACRYLIC OVAL BOXES VOAB-1, VOAB-2 FOR VICHY SHOWER WALL MOUNTING</p> <p style="text-align: right;">2PCS.</p> <p>7. DECO SCREENS</p> <p>NOTE: THIS MODEL ALLOWS TO INSTALL CONTROL PANEL REMOTELY UPON CUSTOMER’S CHOICE. CHARCOT OPTION AVAILABLE.</p>	
---	---	--



CHAPTER 5. EXAMPLES OF JUMBO LINE TUBS SHIPPING DIMENSIONS AND WEIGHTS.

NOTE 1: FREIGHT COMPANIES CALCULATE AIR FREIGHT CHARGE FOR THE CRATED TUBS BASED ON DIMENSIONAL WEIGHT.

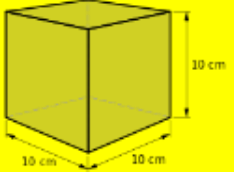
NOTE 2: FOR FULL CONTAINER SHIPMENTS FREIGHT CHARGE IS CALCULATED BASED ON THE ACTUAL ORDER. AVERAGE 40 FOOT HC CONTAINER WILL COST YOU ABOUT \$4,000.00. PRICE MAY VARY SLIGHTLY DEPENDING ON THE" PORT OF ENTRY" (PORT WHERE CARGO IS UNLOADED AND ENTERS A COUNTRY.)

NOTE 3: LESS THAN CONTAINER LOAD WILL BE CALCULATED BASED ON THE WEIGHT AND DIMS OF THE SHIPMENT.

#	TUB MODEL 	TUB DIMENSIONS 	SAFETY STEP DIMENSIONS, WEIGHT.  NOTE: DIMS OF THE DOUBLE STEP SAFETY LADDER AND SINGLE STEP SAFETY LADDER ARE THE SAME FOR ALL "JUMBO LINE" TUBS. 	TUB ACTUAL WEIGHT 				CHARGEABLE SHIPPING WEIGHT/VOLUME M ³ 
				GROSS W-T APP. CRATED		NET WEIGHT APP.		
				LBS	KGS	LBS	KGS	
1	C-280 T MA-08 <i>CRYSTAL COVE LE</i> LIMITED EDITION INTELLI-TUB®	CRATED: 96" (L) X 49" (W) X 53" (H) 244CM (L) X 124CM (W) X 135CM (H) INSTALLED ON-SITE: 90" (L) X 43" (W) X 46" (H) 229CM (L) X 109CM (W) X 116CM (H)	DOUBLE STEP LADDER BOXED: FOR SHIPPING:  42" (W) X 29" (D) X 26" (H) 107CM (L) X 74CM (W) X 65CM (H) VOL: 14.97 SQ.FT/0.515M3 SHIPPING WEIGHT: 44LBS (20 KGS.) DOUBLE STEP LADDER: NON-BOXED SIZE: W 40" X DEPTH 27" X H 16" 1020MM. X 690MM. X 410MM. NET WEIGHT: 26LBS./15KGS	919	417	678	308	4.1M ³

2	C-280 T MA-08 <i>CRYSTAL COVE</i> INTELLI-TUB®	CRATED: 96" (L) X 49" (W) X 49" (H) 244CM (L) X 124CM (W) X 125CM (H)	SINGLE STEP LADDER BOXED: <u>SEE ACTUAL SIZE IN THE TUB DRAWINGS</u> 39 ½" (L) X 20" (W) X 10" (H) 100CM (L) X 51CM (W) X 25CM (H)	874	397	636	289	3.8M ³
		INSTALLED ON-SITE: 90" (L) X 43" (W) X 38" (H) 229CM (L) X 109CM (W) X 97CM (H)						
3	C-280 T MA-08 <i>SEA BREEZE</i> INTELLI-TUB®	CRATED: 96" (L) X 49" (W) X 49" (H) 244CM (L) X 124CM (W) X 125CM (H)	SINGLE STEP 	693	315	581	264	3.8M ³
		INSTALLED ON-SITE: 90" (L) X 43" (W) X 38" (H) 229CM (L) X 109CM (W) X 97CM (H)						
4	C-280 T MB-08 <i>SEA CORAL</i> INTELLI TUB®	CRATED: 96" (L) X 49" (W) X 48" (H) 244CM (L) X 124CM (W) X 122CM (H)	ACTUAL SIZE. 39" (W) X 19" (D) X 9" (H) 107CM (L) X 74CM (W) X 23CM (H)	593	270	535	243	3.7M ³
		INSTALLED ON-SITE: 90" (L) X 43" (W) X 38" (H) 229CM (L) X 109CM (W) X 97CM (H)						
5	C-280 T MC-08/S <i>SEABAY SPA</i>	CRATED: 96" (L) X 49" (W) X 46" (H) 244CM (L) X 124CM (W) X 117CM (H)		563	256	411	187	3.6M ³
		INSTALLED ON-SITE: 90" (L) X 43" (W) X 38" (H) 229CM (L) X 109CM (W) X 97CM (H)						
6	C-280 T MC-08/O <i>OCEAN FLOWER</i>	CRATED: 96" (L) X 49" (W) X 46" (H) 244CM (L) X 124CM (W) X 117CM (H)		533	242	363	165	3.6M ³
		INSTALLED ON-SITE: 90" (L) X 43" (W) X 36 ½" (H) 229CM (L) X 109CM (W) X 93CM (H)						

CHAPTER 6.

EXAMPLE OF TUB UNCRATING AND HANDLING ON-SITE.

STEP 1 REMOVE WOODEN SCREWS FROM TOP PLYWOOD LID. YOU WILL NEED 2 PEOPLE TO REMOVE LID FROM THE CRATE AND PUT IT ASIDE THEN.



STEP 2 REMOVE WOODEN SCREWS FROM LONG SIDE PANELS. YOU WILL NEED 2 PEOPLE TO REMOVE LONG SIDE PANELS FROM THE CRATE AND PUT THEM ASIDE THEN.



STEP 3 REMOVE WOODEN SCREWS FROM FRONT AND BACK CAP SIDE PANELS. YOU WILL NEED 2 PEOPLE TO REMOVE FRONT AND BACK CAP SIDE PANELS FROM THE CRATE AND PUT THEM ASIDE THEN.

STEP 4

AFTER ALL SIDE PANELS HAVE BEEN REMOVED YOU WILL NEED 2 PEOPLE TO LIFT AND CAREFULLY MOVE AWAY TWO SEGMENTS OF FAIRING (LOWER SKIRT) THAT ARE PACKED INSIDE THE CRATE AROUND THE BASE OF THE TUB BOTH SEGMENTS ARE WRAPPED IN BUBBLE WRAP TO AVOID SCRATCHING. **FOR MODELS EQUIPPED WITH FAIRING.** SPECIAL SKIRT DESIGN FEATURES NEW ELEGANT FAIRING WITH CHROME MOLDING. FAIRING IS WRAPPING AROUND THE TUB TO COVER (FILL) THE CLEARANCE BETWEEN THE BOTTOM OF THE TUB AND FLOOR TO HIDE PLUMBING, ETC.
NOTE 1: PHOTOS SHOW THE DIFFERENCE BETWEEN MODELS EQUIPPED WITH FAIRING AND MODELS WITHOUT FAIRING.



STEP 5

REMOVE WOODEN SCREWS FROM SPECIAL WOODEN STOPPERS THAT PREVENT TUBS' FEET FROM MOVING ON THE CRATE BASE. PUT STOPPERS ASIDE.

